

**TYPE EC15--**

**VX42  
4WD**

**VORTEX-PRO™  
Robotic Pool Cleaner  
Owner's Manual**

**⚠ WARNING**

**FOR YOUR SAFETY - For anything other than the routine cleaning and maintenance described in this manual, this product must be serviced by a pool technician who is licensed and qualified in pool equipment by the jurisdiction in which the product will be installed where such state or local requirements exist. In the event no such state or local requirement exists, the pool technician must be a professional with sufficient experience in pool equipment installation and maintenance so that all of the instructions in this manual can be followed exactly. Improper installation and/or operation will void the warranty.**

# Table of Contents

<b>Section 1. Important Safety Instructions</b>	<b>3</b>
<b>Section 2. Cleaner Specifications</b>	<b>4</b>
2.1 General Specifications	4
<b>Section 3. Assembly</b>	<b>4</b>
3.1 Unpacking	4
3.2 Connecting the Control box to base	4
3.4 Connecting Floating Cable to Control Box	4
<b>Section 4. Operation</b>	<b>5</b>
4.1 Submerging the Cleaner	6
4.2 The VX42 Cleaner Control box	7
4.3 Starting the Cleaner	7
4.4 Stopping the Cleaner and Removing from the Pool	7
4.5 Storing the Cleaner	8
<b>Section 5. Cleaning and Maintenance</b>	<b>8</b>
5.1 Cleaning the Filter Canister	8
5.2. Cord Tangling	9
5.3 Replacing the Brushes	10
5.4 Replacing the Tyres	11
<b>Section 6. Troubleshooting</b>	<b>12</b>
6.1 Using the Information LED for Troubleshooting (VX42 Cleaner)	12
6.2 General Troubleshooting	13
<b>Section 7. Conformity</b>	<b>14</b>

THANK YOU FOR PURCHASING THIS ROBOTIC POOL CLEANER BY ZODIAC®.

YOUR CLEANER HAS BEEN DESIGNED AND MANUFACTURED TO BE EASILY INSTALLED AND TO PROVIDE LOW MAINTENANCE OPERATION. A WARRANTY CARD IS SUPPLIED IN THE BOX. PLEASE GO TO [ZODIAC.COM.AU](http://ZODIAC.COM.AU) TO REGISTER FOR WARRANTY.

Taking these steps will help ensure prompt warranty service, should it be required. If service is required, please contact your original dealer. If the original dealer does not perform warranty service, please visit [www.zodiac.com.au](http://www.zodiac.com.au) to locate an independent service company near you. If you are unable to locate a service company, please call our After Sales Support Team at 1300 763 021.

In the case your product may require a service or warranty repair, please retain the original carton to transport your cleaner in.

# Section 1. Important Safety Instructions

Congratulations on purchasing the Zodiac robotic cleaner. Please read through the entire manual before installing the cleaner. Your cleaner must be installed and operated as specified.

## READ AND FOLLOW ALL INSTRUCTIONS

### **⚠ WARNING**

**Failure to comply with the following warnings can increase risk of fire or electrocution which can result in property damage and serious injury, including loss of life.**

#### **PREVENT ELECTRICAL SHOCK**

To reduce risk of electrical shock:

- The cleaner is to be installed in accordance with the relevant requirements of the Australian wiring rules AS/NZS 3000. Also refer to the installation instructions relating to the swimming pool equipment for which the cleaner will be an integral part. The cleaner is to be supplied through a Residual Current Device (RCD) with a rated residual operating current of 30mA.
- Do not enter pool while the robotic cleaner is in water.
- Do not bury cord. Locate cord so as to prevent it from being damaged by lawn mowers, hedge trimmers and other equipment.
- To reduce the risk of electrical shock, do not use the robotic cleaner or control box if the cord is worn or damaged. Contact Zodiac Customer Care Service 1300 763 021 immediately for proper servicing and replacement of the damaged cord.
- Double insulation—For continued protection against possible electric shock, use only identical replacement parts when servicing. Do not attempt repair of the robotic cleaner, control box, power cord, or floating cable.
- Use only the power supply provided with the product.
- NEVER OPEN Control box.
- DO NOT USE AN EXTENSION CORD TO CONNECT THE UNIT TO ELECTRIC SUPPLY; PROVIDE A PROPERLY LOCATED RCD PROTECTED POWER OUTLET. THE CONTROL BOX SHOULD BE PLACED NEAR THE RCD PROTECTED POWER OUTLET POINT.

#### **PREVENT CHILD INJURY AND DROWNING**

- To reduce the risk of injury, do not permit children or persons with reduced physical, sensory or mental capabilities, or lack of experience and knowledge to operate this product.
- Do not let anyone, especially small children, sit, step, lean, or climb on any equipment installed as part of your pool's operational system.

### **⚠ CAUTION**

**Failure to comply with the following warnings could cause damage to pool equipment or personal injury.**

- The robotic cleaner must be installed and operated as specified.
- This product is intended for use with permanently-installed pools. Do not use with storable pools. A permanently-installed pool is constructed in or on the ground or in a building such that it cannot be readily disassembled for storage. A storable pool is constructed so that it is capable of being readily disassembled for storage and reassembled to its original integrity.
- Clean the filter canister after each use.
- Do not use the product in your pool if the water temperature is above 35° C (95° F) or below 13° C (55° F).

### **⚠ CAUTION**

#### **USE OF THE ZODIAC ROBOTIC CLEANER IN A VINYL LINER POOL**

Certain vinyl liner patterns are particularly susceptible to rapid surface wear or pattern removal caused by objects coming into contact with the vinyl surface, including pool brushes, pool toys, floats, fountains, chlorine dispensers, and automatic pool cleaners. Some vinyl liner patterns can be seriously scratched or abraded simply by rubbing the surface with a pool brush. Ink from the pattern can also rub off during the installation process or when it comes into contact with objects in the pool. Zodiac Pool Systems, Inc., is not responsible for, and the Limited Warranty does not cover, pattern removal, abrasion or markings on vinyl liners.

## SAVE THESE INSTRUCTIONS

## Section 2. Cleaner Specifications

### 2.1 General Specifications

The general specifications for the cleaner are as follows:

<b>Control box supply voltage</b> 	220-240 VAC, 50 Hz; short circuit-proof safety isolating type
<b>Supply voltage</b>	30 V DC
<b>Installed load</b>	150 W max
<b>Cable length</b>	VX42 4WD: 15m Swivel Cable
<b>Cleaner size (WxDxH)</b>	43 x 48 x 27 cm
<b>Weight of Cleaner</b>	9.5 kg
<b>Packed weight</b>	19 kg
<b>Filtration</b>	All-purpose filter canister
<b>Cycle lengths</b>	Variable programming for cleaning floor, walls, and waterline. From 1.5 - 3.0 hours.
<b>Filter Canister</b>	200 microns

The cleaner is a double-insulated product. A double-insulated electrical appliance is one which has been designed in such a way that it does not require a safety connection to ground. The basic requirement for double-insulation is that no single failure can result in dangerous voltage becoming exposed so that it might cause an electric shock and that this is achieved without relying on an earthed (grounded) metal casing. This is achieved by having two (2) layers of insulating material surrounding live parts or by using reinforced insulation. Therefore, devices having double-insulated construction, such as this cleaner, do not utilize a grounded (three-prong) cord/plug.

## Section 3. Assembly

### 3.1 Unpacking

The packaging should contain the following items:

- Robotic cleaner
- Control box
- Control box base (VX42)

When unpacking the cleaner and its components:

- Check to make sure each component is in the box.
- Check cleaner and components for damage during transport.
- If there are any missing parts or damage, contact Zodiac® at 1300 763 021.

### 3.4 Connecting the control box to base

1. Align the bottom of the control box with the notch in the base (see Figure 1).
2. Press control box down firmly to snap in place.

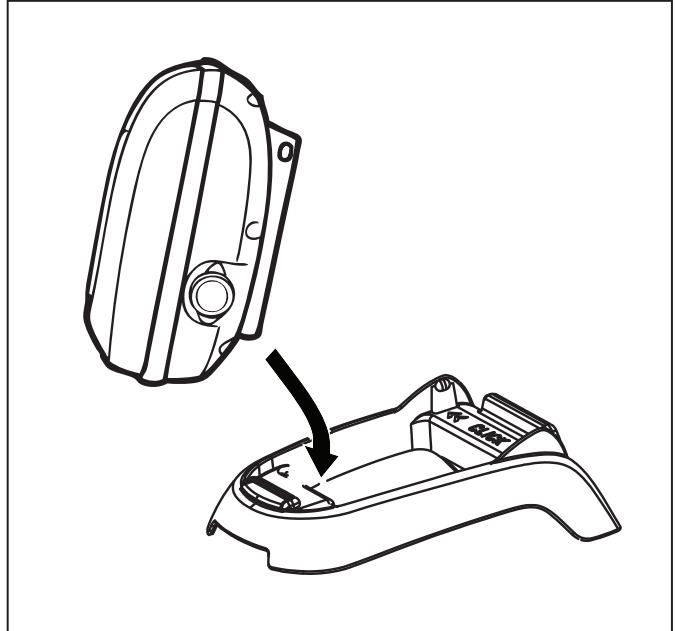

Figure 1. Attach Control box to Base

### 3.3 Connecting Floating Cable to Control Box

#### **WARNING**

Failure to comply with the following warnings can increase risk of fire or electrocution which can result in property damage and serious injury, including loss of life.

#### **PREVENT ELECTRICAL SHOCK**

- Keep the control box at least 3.5 m from the edge of the pool.
- The cleaner is to be installed in accordance with the relevant requirements of the Australian wiring rules AS/NZS 3000. Also refer to the installation instructions relating to the swimming pool equipment for which the cleaner will be an integral part. The cleaner is to be supplied through a Residual Current Device (RCD) with a rated residual operating current of 30mA.
- Do not use an extension cord to connect the control box.
- Do not allow anyone to swim while the cleaner is in the pool.
- The control box is water-resistant, not waterproof. In order to prevent electrocution, never submerge the control box or leave exposed to inclement weather.

1. Unscrew the protective cap for the power cable from the side of the control box by turning counter-clockwise (Figure 2).

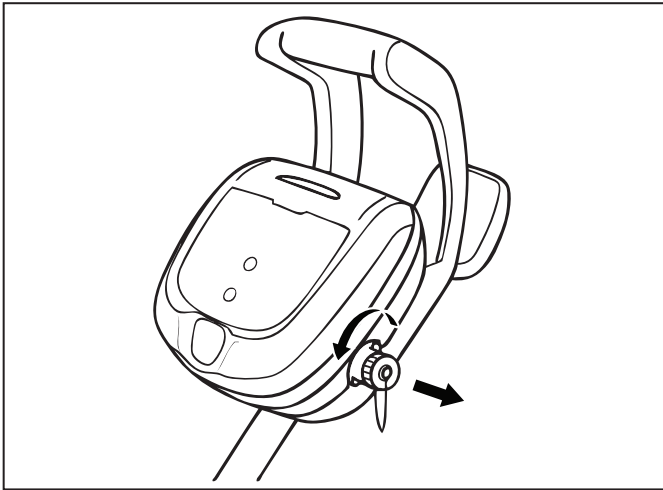

**Figure 2. Remove Protective Cap**

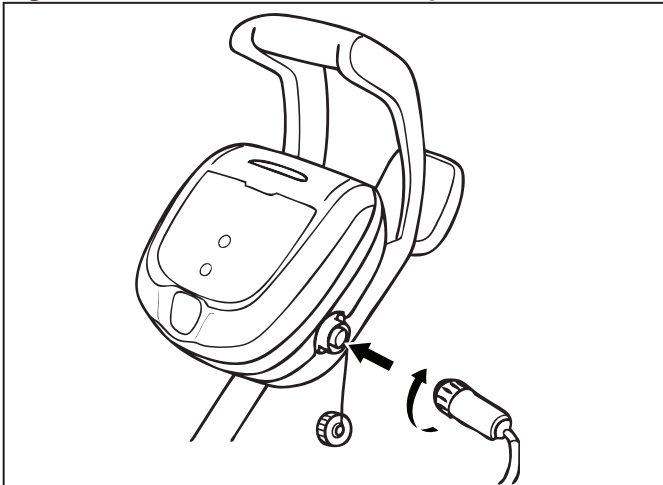

**Figure 3. Connect Power Cable**

2. Grip the notched end of the floating power cable, insert into the control box, and turn clockwise to tighten. (Figure 3.)

**NOTE:** To avoid damaging the power cable, do not try to twist the entire cable housing (see below).

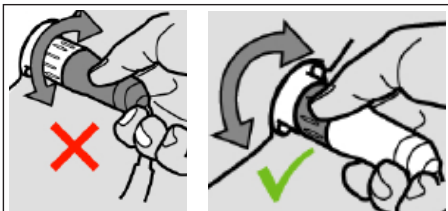

**NOTE:** To avoid exposing the power cable connector pins to water, be sure the connector is screwed in all the way and there is no gap. (see below).

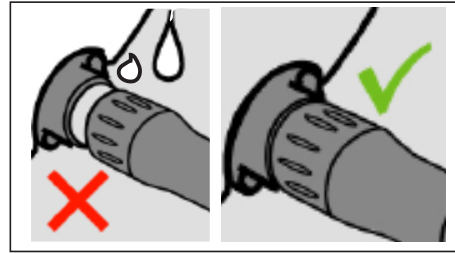

## Section 4. Operation

### ⚠ CAUTION

To prevent damage to the cleaner, be sure to adhere to the following guidelines:

- Remove the cleaner from the pool after the cleaning cycle is completed and store on the caddy out of direct sunlight or inclement weather.
- Store the cleaner out of direct sunlight or inclement weather. Store the control box on the base as shown in Figure 1.
- Never lift the cleaner out of the pool by the floating cable. Always use the lift feature to remove cleaner from the pool.
- Take additional care when lifting the cleaner out of the pool. It becomes heavier when filled with water.
- Always remove the cleaner from pool when super chlorinating or adding acid.
- Do not handle cleaner while it is in operation.

### IMPORTANT

- Always make sure the cleaner head is fully submerged before you begin operation.
- Clean the filter canister after each cleaning cycle.
- Do not leave your cleaner in the pool on a permanent basis.
- At the end of each cycle, remove the cleaner from the pool. Start at the cleaner head and untangle any coils in the cable before storing the cleaner.

When the control box is powered on with the floating cable attached, the operating time for the current selected cycle is displayed.

The robotic cleaner includes a safety feature that automatically stops the cleaner if it is powered on but not submerged in water. For pools equipped with a beach area, this safety feature is programmed to drive the cleaner in reverse and back into the pool when the impeller is out of the water.

#### 4.1 Submerging the Cleaner

1. Submerge the cleaner in the pool and remove any air trapped inside by keeping the unit vertical (Figure 4).

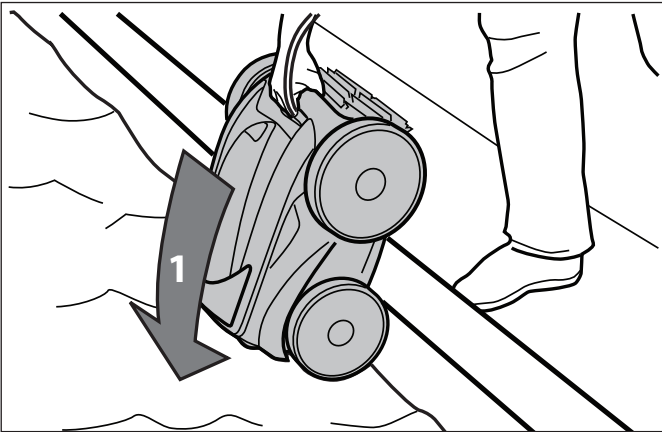

Figure 4. Submerge the Cleaner Vertically

2. Ensure the unit sinks to the bottom of the pool and does not float (Figure 5).

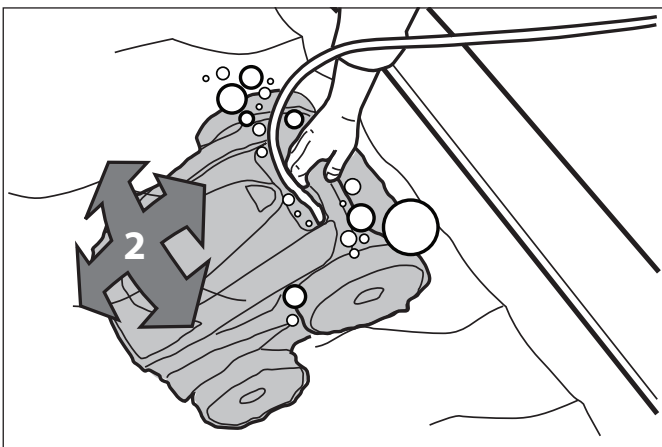

Figure 5. Cleaner Sinking to the Bottom of the Pool

3. Spread out the floating cable over the pool, ensuring there are no kinks or coils in the cable.

**NOTE:** For optimal patterning and reduced tangling, the floating cable should enter the water near the middle of the pool length. Only place enough cable in the water to reach the farthest point in the pool (see Figure 6).

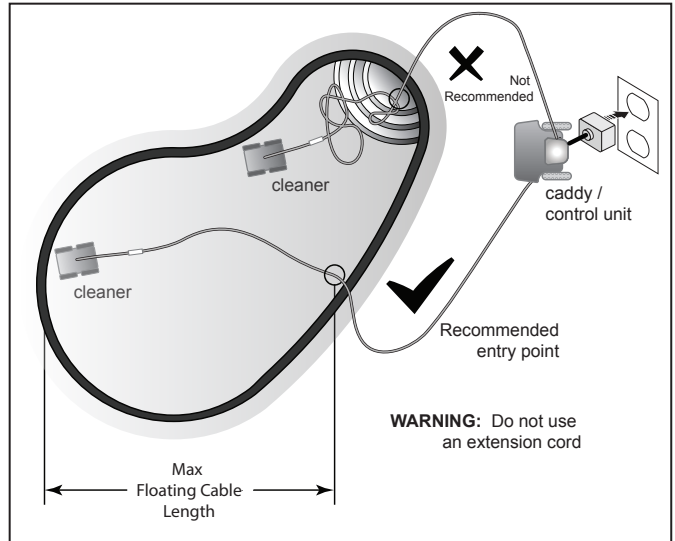

Figure 6. Setup for Optimal Patterning

## 4.2 The VX42 Cleaner Control box

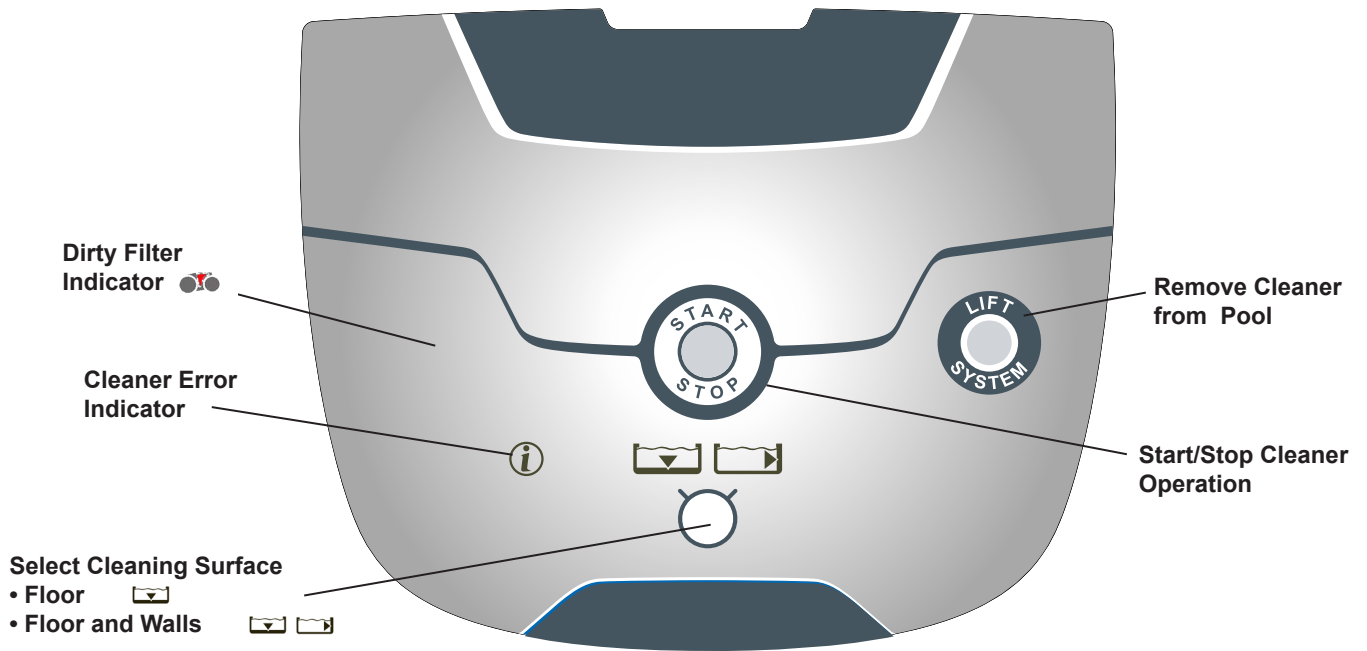

Figure 7. VX42 Control Box

## 4.3 Starting the Cleaner

The default cleaning surface setting for the Vortex cleaners is Floor Only .

### Select Cleaning Surface (all models):

Use   to change cleaning surface setting.



Toggle between:  **Floor Only**  
 **Floor and Walls**

### Begin Cleaning:

After selecting the cleaning surface and other options as applicable, press  to begin operation.

## 4.4 Stopping the Cleaner and Removing from the Pool

The automated Lift System makes removing the cleaner from the pool simple. The Lift System will move the cleaner toward the edge of the pool then drive it to the surface for removal.

1. At the end of the cleaning cycle, or at any time during a cleaning cycle, press  to begin the

automated lift procedure.

Press and hold the Lift System button to turn cleaner to the left. Cleaner will keep rotating left. Once the cleaner is oriented towards the wall of your choice, release the button.

Press and release the Lift System button and the cleaner will drive up the wall and to the waterline and wait to be retrieved.

**NOTE:** To stop the lift procedure at any time, press .

2. When the cleaner is within arm's reach, use the handle to remove from the water (Figure 8, 9). Never lift the cleaner out of the pool by the floating cable.

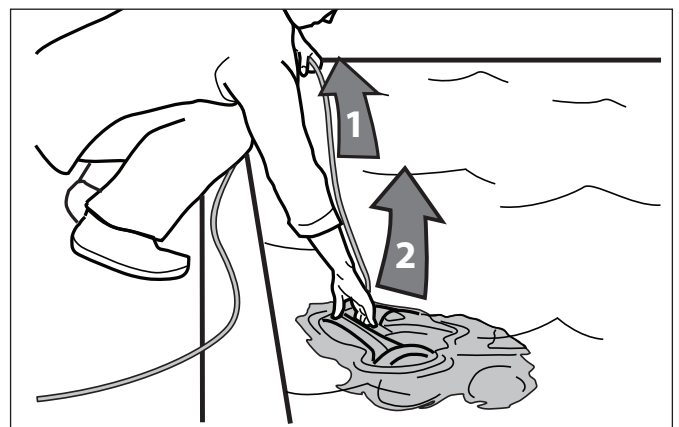
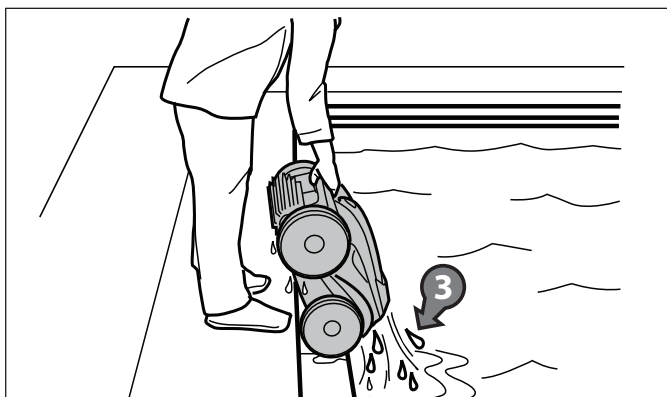

Figure 8. Remove Cleaner From Pool with Handle



**Figure 9. Keep Cleaner Vertical to Drain Water**

#### 4.5 Storing the Cleaner

The cleaner must be cleaned regularly using slightly soapy clean water. Do not use solvents such as acetone or its equivalent. Rinse the cleaner generously using clean water. Do not let your cleaner dry in direct sunlight near the pool.

**NOTE:** Store the VX42 cleaner out of direct sunlight or inclement weather. Store the control box on the base (see Figure 1).

1. Disconnect the floating cable from the control box. Replace the protective cap on the control box.
2. Starting at the cleaner head. Remove all coils and tangles from the floating cable (Figure 10).

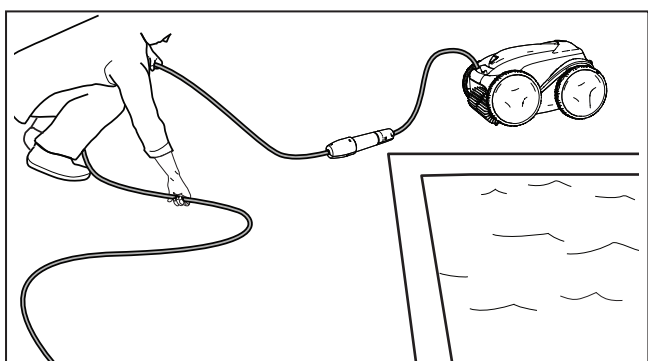

**Figure 10. Untangle the Floating cable**

3. Loosely coil the floating cable starting at the cleaner and moving toward the connection point at control box.

## Section 5. Cleaning and Maintenance

### **⚠ WARNING**

To avoid electric shock and other hazards which could result in permanent injury or death, disconnect (unplug) the control box from the power source before performing any cleaning and maintenance.

#### 5.1 Cleaning the Filter Canister

The filter canister should be cleaned at the end of each cycle.

1. Make sure the control box cable is disconnected from the electrical outlet or the floating cable has been disconnected from the control box.
2. Remove the cleaner from the water and let the remaining water drain by maintaining the cleaner in the vertical position.
3. Set the unit on its wheels.
4. To remove the filter canister assembly from the cleaner, follow steps 5 through 8.
5. Push the cover lock (1) and lift the cover (2) until it is secured in the vertical position. (Figure 1).

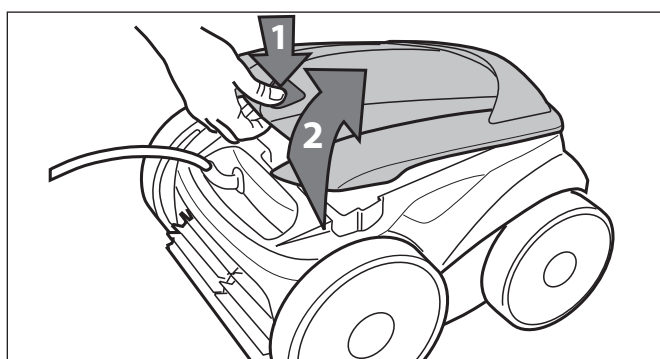

**Figure 11. Lift Cleaner Cover**

6. Remove the filter canister assembly from the body (3), as shown in Figure 12



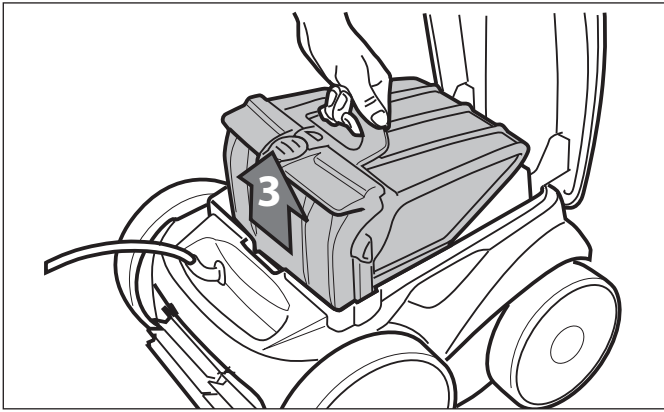

**Figure 12. Remove Filter Canister Assembly**

7. Push the quick release button on the canister assembly (4) and pull open the filter assembly (5), as shown in Figure 13.

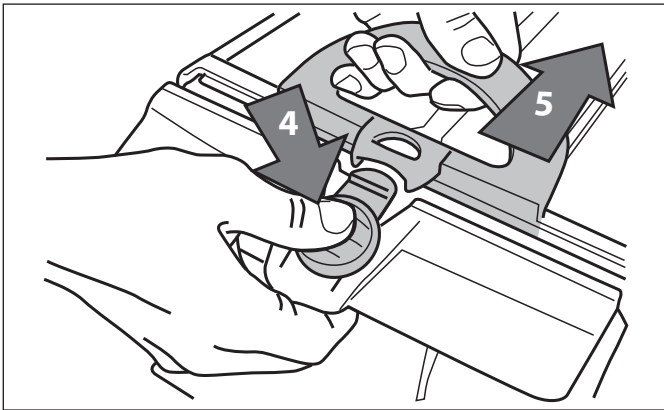

**Figure 13. Open Filter Canister Assembly**

8. Separate the filter canister from the filter support (6), as shown in Figure 14.

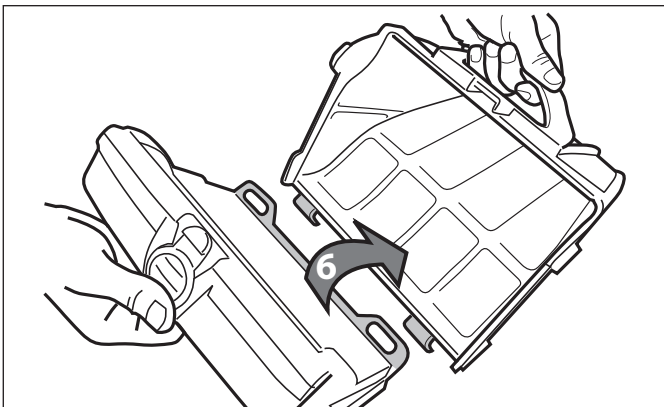

**Figure 14. Remove Filter Canister**

9. Empty all debris from the filter canister, then rinse the canister, the filter support, and the cleaner under water or using a hose, as shown in Figure 15.

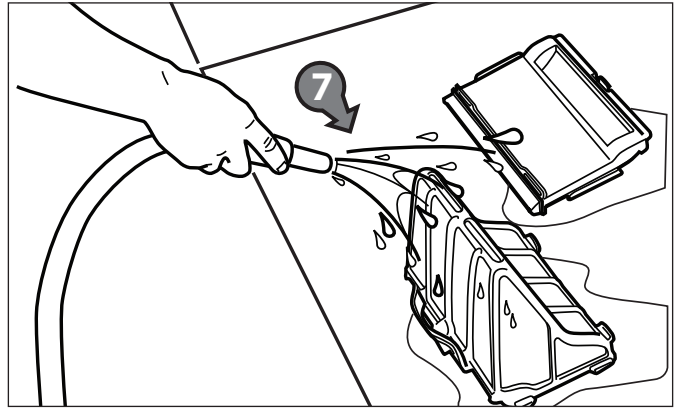
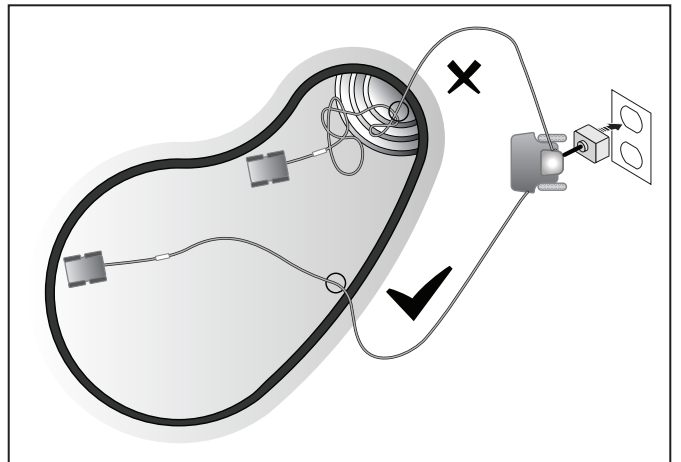

**Figure 15. Wash Filter Canister**

## 5.2. Cord Tangling

Spread out the floating cable over the pool, ensuring there are no kinks or coils in the cable. Do not leave the cleaner unattended for prolonged periods and follow procedure below to avoid excessive tangling.

**NOTE:** For optimal patterning and reduced tangling, the floating cable should enter the water near the middle of the pool length. Only place enough cable in the water to reach the farthest point in the pool.



## After every cleaning cycle:

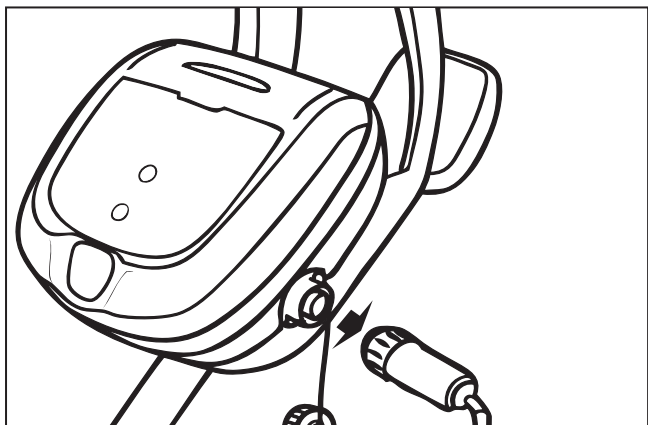

1. Unplug the floating cable at the control box.

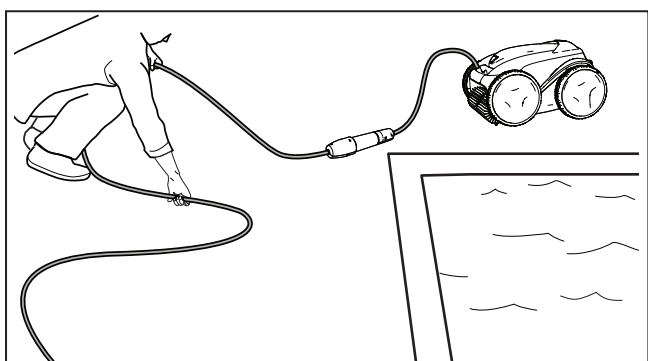

2. Remove the cleaner from the pool and untangle any kinks and coils in the floating cable starting at the cleaner head.

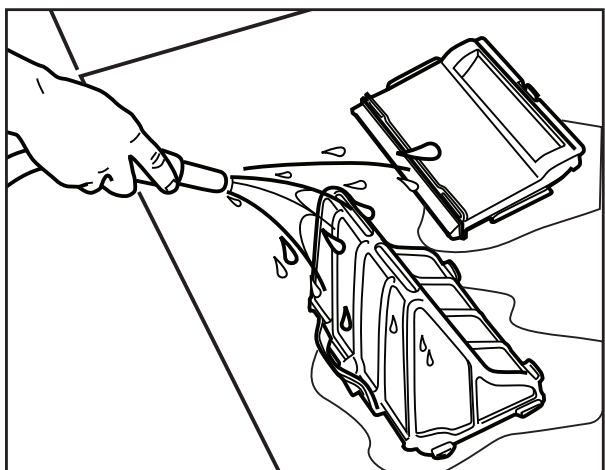

3. Remove filter canister and rinse with clean water. Plug the floating cable back into the control box and store cleaner for next use.

## 5.3 Replacing the Brushes

The cleaner is fitted with PVC brushes. There are "wear" indicators on the brushes (Figure 1). To maintain cleaner performance at its best you need to replace the brushes as soon as one of the wear indicators is reached (even if the blade wear is not even). It is recommended that you replace the brushes when the rubber is worn down to the top of the wear indicator (or every two years, whichever comes first).

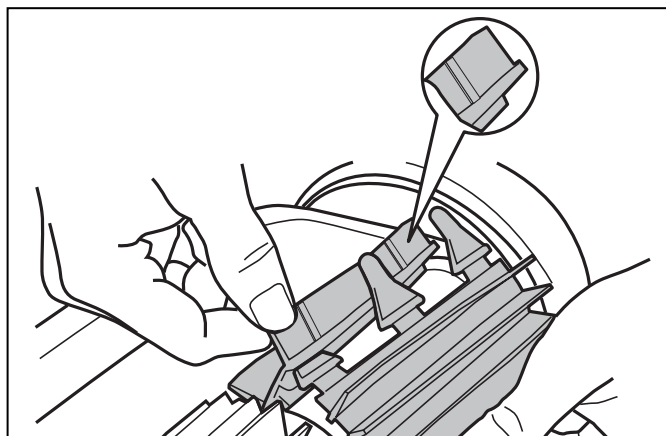

Figure 16. Wear Indicators

1. Lift the cleaner to a vertical position so that the handle is up (Figure 17).

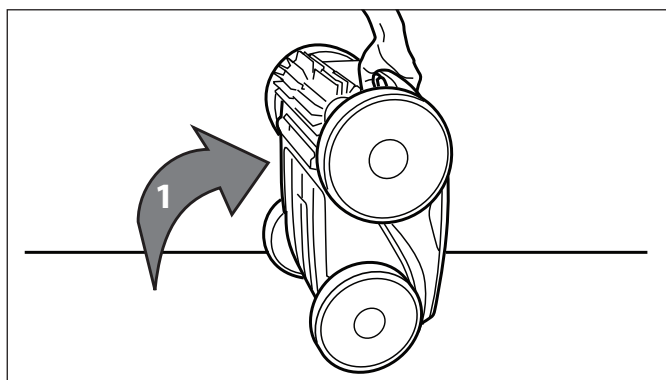

Figure 17. Cleaner in Upright Position

2. Separate the edges of the brush and undo the tabs (Figure 18). Remove the worn brushes.

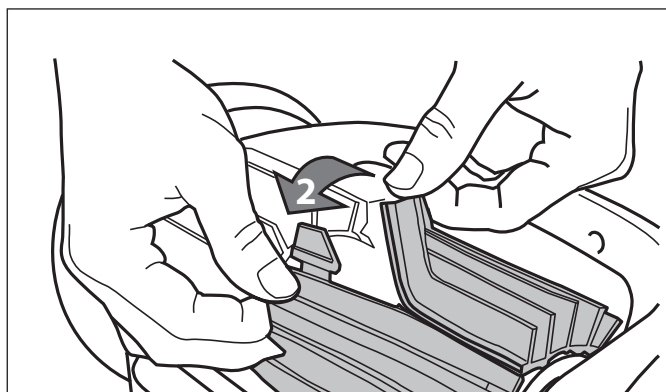
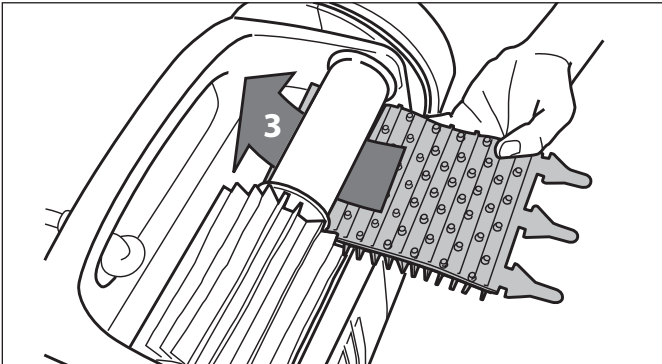

Figure 18. Undo the Tabs of the Brush

- To install a new brush matt, position the new brush matt on the roller with the bristles facing downwards (Figure 19).



**Figure 35. Install the New Brush**

- Thread each tab into the slot provided and gently feed it through until the heel comes out at the other side of the slot (Figure 20).

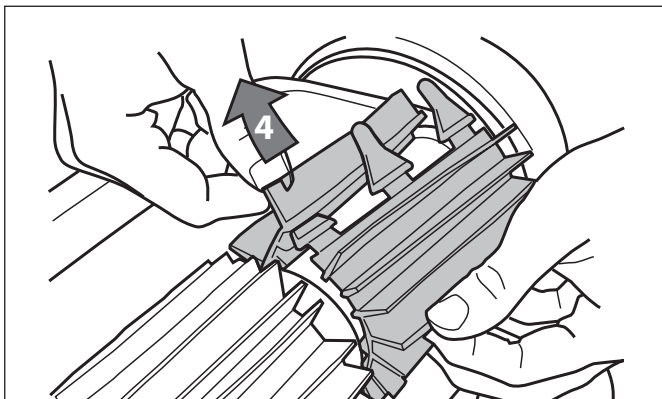

**Figure 20. Pull Tabs Through Each Slot**

- Use scissors to cut the tabs at the guides, as shown in Figure 21.

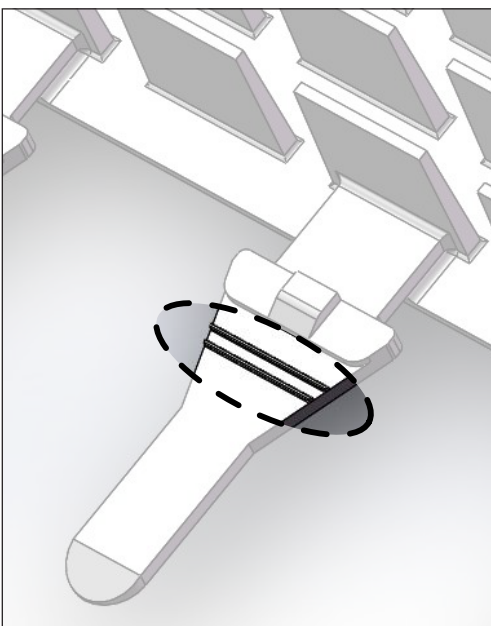
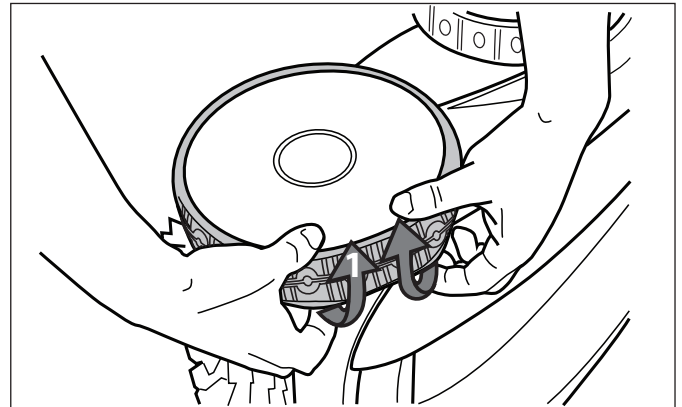

**Figure 21. Cut Tabs**

- Repeat this procedure to replace the second brush matt.

## 5.4 Replacing the Tyres

- Pull on the inside of the old tyre to remove the tyre lip from the wheel (Figure 22).



**Figure 22. Pull the Old Tyre Over the Wheel**

- Remove the old tyre (Figure 23).

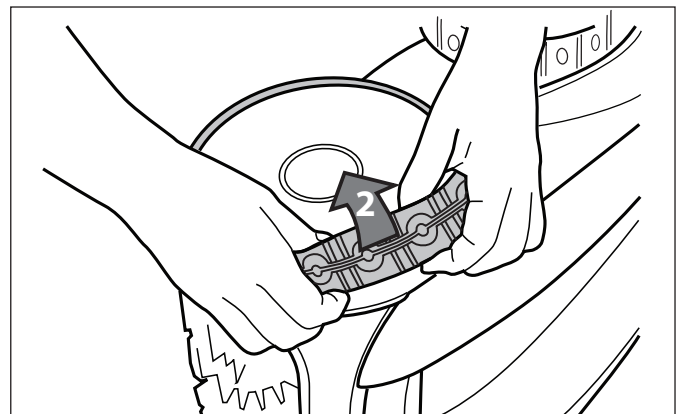

**Figure 23. Remove the Old Tyre**

- To replace the tyre, position the tyre on the wheel making sure to orient the tyre so that the word **INSIDE** is toward the body of the cleaner (Figure 24).

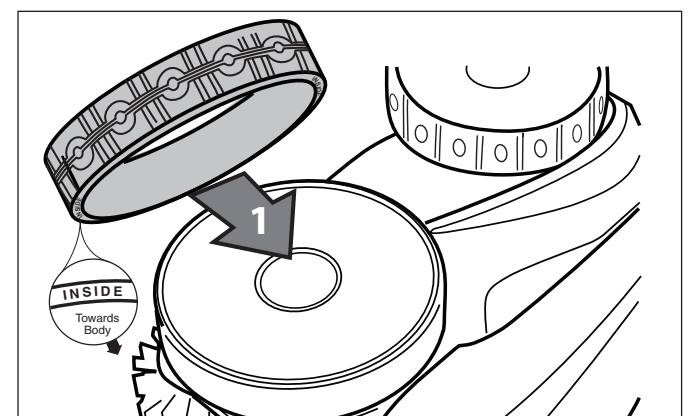

**Figure 24. Tyre Replacement Orientation**

- Push one side of the tyre on to the wheel and fit the rib of the tyre in the groove of the wheel (Figure 25).

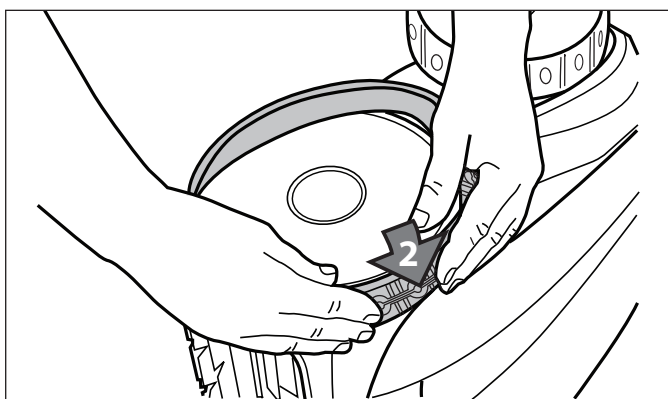

**Figure 25. Start on One Side of the Tyre**

5. Work the tyre onto the wheel and verify the rib of the tyre is positioned properly within the groove of the wheel (Figure 26).

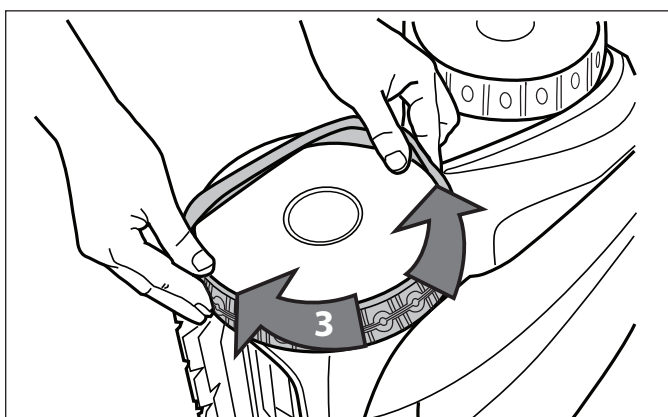

**Figure 26. Work the Tyre On Around the Wheel**

6. Push and position the rib of the inner side of the tyre in the groove of the wheel (Figure 43B). If needed, turn the wheel gently to help with installation.

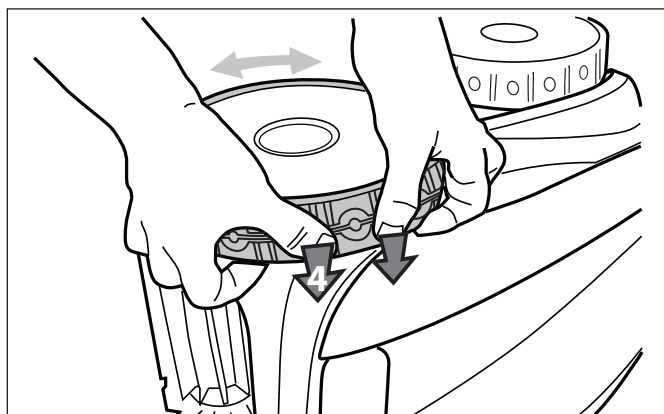

**Figure 27. Push the Tyre into Place on the Wheel**

## Section 6. Troubleshooting

### 6.1 Using the Information LED for Troubleshooting (VX42 Cleaner)

The Information LED  on the control box flashes in a specific sequence to indicate one of three possible cleaner malfunctions.

Information LED Flashing	Solution
LED flashes once with one second interval.	Unplug the floating cable from the control box and reconnect. If the problem is not resolved through troubleshooting, contact Zodiac After Sales Support at 1300 763 021.
LED flashes twice with one second interval	Turn cleaner wheels to ensure they are not jammed. Check brushes for debris. Start a new cleaning cycle. If the problem persists, contact Zodiac After Sales Support at 1300 763 021.
LED flashes three times with one second interval	Check propeller for debris. Clean the filter. Start a new cleaning cycle. If the problem persists, contact Zodiac After Sales Support at 1300 763 021.

## 6.2 General Troubleshooting

The following table lists some of the common symptoms, causes, and solutions for correcting cleaner operation problems.

Problem	Cause	Solution
The flashing indicator lights	Floating cable may not be plugged into the control box correctly.	Unplug floating cable from the control box and reconnect.
	Cleaner may not be fully submerged.	Remove cleaner from the pool and re-submerge, see <i>Submerging the Cleaner</i> .
	Cleaner may need to be reset and begin a new cycle.	Turn control box power OFF, then back ON, then restart the cleaner.
	Propeller may be jammed and not turning correctly.	Contact Zodiac After Sales Support at 1300 763 021.
	Wheels may be jammed and not turning correctly.	Contact Zodiac After Sales Support at 1300 763 021.
The flashing lights appear during the cleaning cycle.	Cleaner may be sucking air (lights will appear after 60 seconds air intake)	Remove cleaner from the pool and re-submerge, see <i>Submerging the Cleaner</i> .
The cleaner does not stay firmly on the pool bottom.	There is air in the appliance casing.	Submerge the cleaner following the procedure in <i>Submerging the Cleaner</i> .
	The filter canister is full or dirty.	Clean the filter canister, see <i>Cleaning the Filter Canister</i> .
The cleaner does not or no longer climbs the pool sides.	The filter canister is full or dirty.	Clean the filter canister, see <i>Cleaning the Filter Canister</i> .
	Sides of pool are slippery or slimy. Although the water seems clear, microscopic algae, invisible to the human eye, are present in the pool. As a result the pool sides become slippery and prevent the cleaner from climbing. Check tyres for wear and replace as necessary.	Do a shock chlorination treatment. DO NOT leave the cleaner in the pool during this treatment.
On startup the cleaner does not move.	Not supplied with electricity.	The outlet, the control box is connected to, is not supplying electrical power. Check that the outlet to which the control box is connected is receiving electricity.
	Unit is turned ON.	Check that you have started one (1) of the two (2) programs and check that the indicator for the selected program is lit. If the indicator light is not lit, turn the wheels then disconnect the control box and wait at least 20 seconds before reconnecting. If the problem persists, contact Zodiac After Sales Support at 1300 763 021.
Cable is tangling in the pool	Too much cable length in the water.	Do not unravel the entire cable length. Place only the required length of cable in the water and place the rest on the side of the pool. Follow the procedure in <i>Cord Tangling</i> to avoid and correct tangled cord.
The cleaner is not cleaning effectively.	The brushes have become smooth or the "wear" indicator shows.	Replace the brushes following the procedure in <i>Replacing the Brushes</i> .
	Filter canister is full or dirty.	Clean the filter canister following the procedure in <i>Cleaning the Filter Canister</i> .
	Floating cable is excessively coiled or kinked.	Make sure the floating cable is spread out over the pool. Ensure the cable is not too tightly wrapped or coiled when storing. If the problem persists, lay the cable straight in the sun to relax it and remove kinks.

---

## Section 7. Conformity



The manufacturer reserves the right to modify these specifications without notice. Although the robotic pool cleaners have been tested in a large variety of swimming pools, Zodiac cannot guarantee that this robotic pool cleaner will be compatible with all pools. Some pool features may affect performance. For further advice, please contact your Zodiac dealer.



**Zodiac Group Australia Pty Ltd.**  
PO Box 7238  
Wetherill Park NSW 2164, Australia  
1300 763 021 | [www.zodiac.com.au](http://www.zodiac.com.au)

ZODIAC® is a registered trademark of Zodiac International, S.A.S.U, used under license.  
All other trademarks used herein are the property of their respective owners.

©2017 Zodiac Pool Systems, Inc. H0516700 Rev C



**ZODIAC®**