



Top Discharge Inverter Heat Pumps



TOP DISCHARGE INVERTER HEAT PUMPS

Installation & Instruction manual

A division of





For full warranty terms and conditions and to register your warranty, simply visit www.astralpool.com.au/warranty and complete your details. Or scan the QR code and be taken directly to the registration page.

Record your equipment details here for quick reference:

Model No.: _____

Serial No.: _____

CONTENTS

1. Preface	1
2. Specifications.....	2
2.1 Performance Data of Swimming Pool Heat Pump Unit.....	2
2.2 Dimensions for Swimming Pool Heat Pump Unit.....	3
3. Installation and Connection	4
3.1 Installation illustration.....	4
3.2 Swimming Pool Heat Pumps Location.....	5
3.3 How Close to Your Pool?.....	5
3.4 Swimming Pool Heat Pumps Plumbing.....	6
3.5 Swimming Pool Heat Pumps Electrical Wiring.....	7
3.6 Initial Start-up of the Unit	7
4. Usage and Operation.....	8
4.1 Color screen wire controller interface introduction.....	8
4.2 Color screen wire controller function introduction.....	9
4.3 Parameter list and breakdown table.....	16
4.4 Interface drawing.....	18
5. Maintenance and Inspection.....	20
6. Appendix.....	21

1. PREFACE

- In order to provide our customers with quality, reliability and versatility, this product has been made to strict production standards. This manual includes all the necessary information about installation, debugging, discharging and maintenance. Please read this manual carefully before you open or maintain the unit. The manufacture of this product will not be held responsible if someone is injured or the unit is damaged, as a result of improper installation, debugging, or unnecessary maintenance. It is vital that the instructions within this manual are adhered to at all times. The unit must be installed by qualified personnel.
- The unit can only be repaired by qualified installer centre , personnel or an authorised dealer.
- Maintenance and operation must be carried out according to the recommended time and frequency, as stated in this manual.
- Use genuine standard spare parts only.
Failure to comply with these recommendations will invalidate the warranty.
- Swimming Pool Heat Pump Unit heats the swimming pool water and keeps the temperature constant. For split type unit, The indoor unit can be Discretely hidden or semi-hidden to suit a luxury house.

Our heat pump has following characteristics:

1 Durable

The heat exchanger is made of PVC 8 Titanium tube which can withstand prolonged exposure to swimming pool water.

2 Installation flexibility

The unit can be installed outdoors.

3 Quiet operation

The unit comprises an efficient rotary/ scroll compressor and a low-noise fan motor, which guarantees its quiet operation.

4 Advanced controlling

The unit includes micro-computer controlling, allowing all operation parameters to be set. Operation status can be displayed on the color screen wire controller. Remote controller can be chosen as future option.

2.SPECIFICATION

2.1 Performance data of Swimming Pool Heat Pump Unit

Product Code	IHPt127	IHPt168	IHPt246
Advised pool volume(m ³)	30-60	40-75	50-100
Operating air temperature (°C)	(-15~43)		
Performance Condition (Air 27°C/Water 26°C/Humid. 80%)			
Heating Capacity(kW)	2.8~12.7	3.9~16.8	5.9~24.6
Heating Capacity(Btu)	9520~43180	13300~57120	2060~83460
Consumed power (kW)	0.22~2.2	0.31~2.98	0.47~4.94
COP	5.77~12.73	5.64~12.58	4.98~12.55
Heating Capacity (Air 15°C/Water 26°C/Humid. 70 %)			
Heating Capacity(kW)	2.2~9.7	2.9~12.8	4.8~18.4
Heating Capacity(Btu)	7480~32980	9860~43520	1252~62560
Consumed power (kW)	0.33~2.13	0.42~2.81	0.73~4.64
COP	4.55~6.67	4.56~6.9	3.96~6.5
Heating Capacity (Air 10°C/Water 26 °C/Humid. 64 %)			
Heating Capacity(kW)	1.9~8.0	2.6~10.8	4.3~18.2
Heating Capacity(Btu)	6460~27200	8840~36720	11552~61880
Consumed power (kW)	0.33~1.95	0.45~2.64	0.74~4.35
COP	4.10~5.76	4.1~5.78	4.18~5.8
Power Supply	230V/1P/50Hz	230V/1P/50Hz	230V/1P/50Hz
Casing type	ABS		
Fan Quantity	1		
Fan Power Input (W)	200	200	200
Fan Speed (RPM)	500-700	500-700	600-800
Sound Pressure 1m dB(A)	42-54	42-56	48-58
Sound Pressure in silence mode 1m dB(A)	42	42	50
Sound Pressure 10m dB(A)	24-34	26-36	30-40
Sound Pressure in silence mode 10m dB(A)	24	26	30
Water Connection (mm)			
Water Flow Volume (m ³ /h)	4.2	5.5	8.0
Water Pressure Drop (max) kPa	3	4	11
Net Dimensions(L/W/H)(mm)	723 _x 835 _x 865	723 _x 835 _x 865	770 _x 990 _x 970
Shipping Dimensions(L/W/H)(mm)	773 _x 885 _x 915	773 _x 885 _x 915	820 _x 1040 _x 1000

2.SPECIFICATION

2.2 The dimensions for Swimming Pool Heat Pump Unit

unit: mm

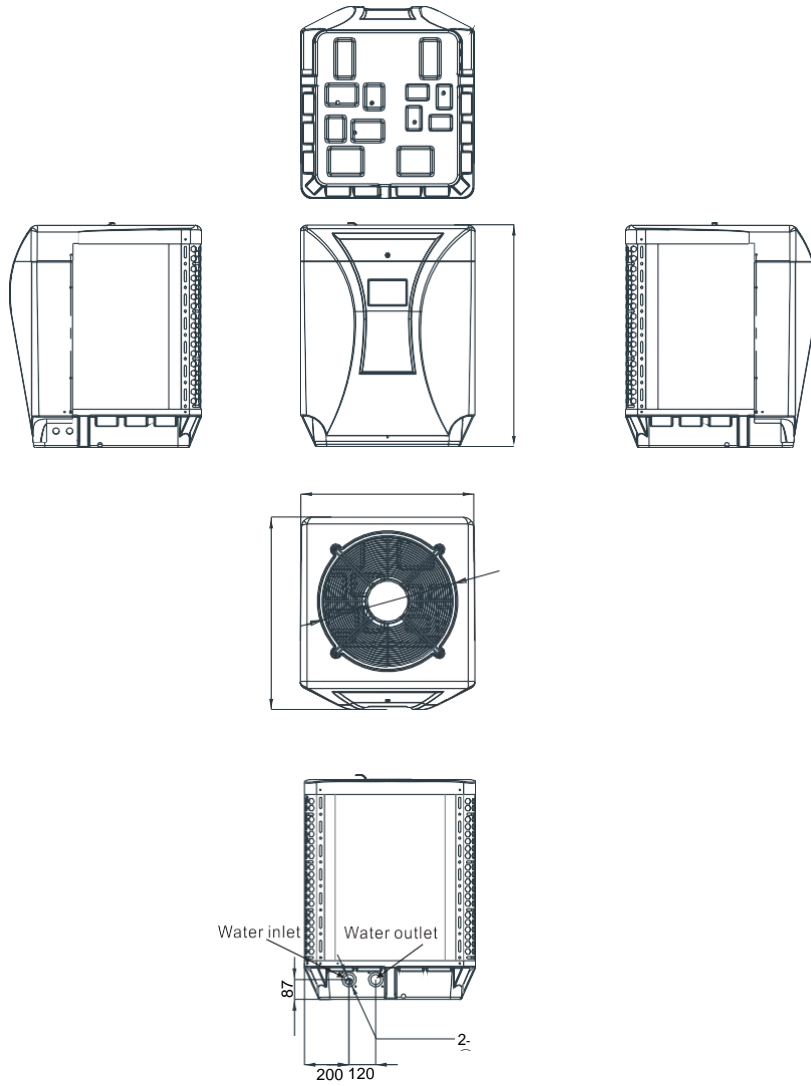

	IHPt127 ^x	IHPt168 ^x	IHPt246 ^x
Dimensions(L/W/H)(mm)	723 835 865	723 835 865	770 990 970

3. INSTALLATION AND CONNECTION

3.1 Installation illustration

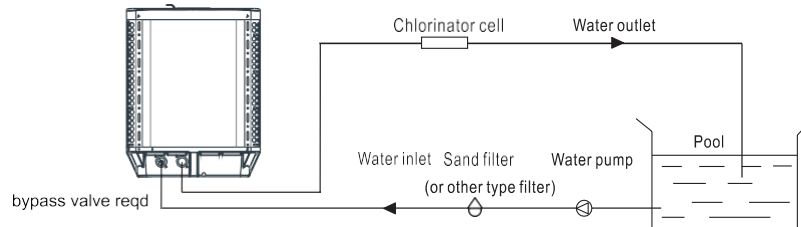

Installation items:

The factory only provides the main unit and the water unit; the other items in the illustration are necessary spare parts for the water system, that provided by users or the installer.

Attention:

Please follow these steps when using for the first time

1. Open valve and charge water.
2. Make sure that the pump and the water-in pipe have been filled with water.
3. Close the valve and start the unit.

ATTN: It is necessary that the water-in pipe is higher than the pool surface.

The schematic diagram is for reference only. Please check the water inlet/outlet label on the heat pump while plumbing installation.

Option to plumb with separate water pump

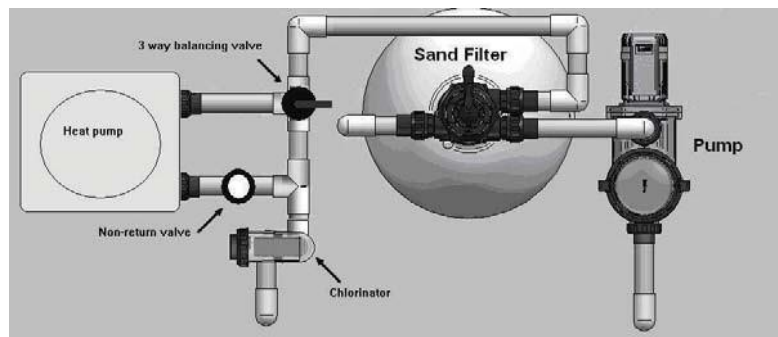

Where the heat pump is installed in the filtration circuit, the heater should always be installed after the pump and filter. The water connections are located on the right hand side of the heater. The inlet and outlet are clearly marked. Water connections supplied are for 50mm PVC glue in plumbing.

All automatic sanitising devices must be installed after the heater and in such a way that the sanitiser cannot enter the heater without first mixing with the water in the pool or spa. Sanitisers that are connected prior to the heater will void heater warranty.

The Astral Pool Heat Pump Pool Heater is only suitable for outdoor installation.

3. INSTALLATION AND CONNECTION

3.2 Swimming Pool Heat Pumps Location

The unit will perform well in any outdoor location provided that the following three factors are presented:

1. Fresh Air
2. Electricity
3. Pool filter piping

The unit may be installed virtually anywhere outdoors. For indoor pools please consult the supplier. Unlike a gas heater, it has no draft or pilot light problem in a windy area.

DO NOT place the unit in an enclosed area with a limited air volume, where the units discharge air will be re-circulated.

DO NOT place the unit to shrubs which can block air inlet. These locations deny the unit of a continuous source of fresh air which reduces its efficiency and may prevent adequate heat delivery.

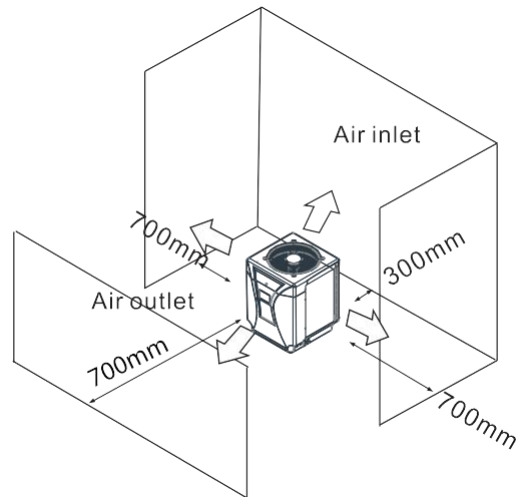

3.3 How Close To Your Pool?

Normally, the pool heat pump is installed within 7.5 metres of the pool. The longer the distance from the pool, the greater the heat loss from the piping. For the most part, the piping is buried. Therefore, the heat loss is minimal for runs of up to 15 meters (15 meters to and from the pump = 30 meters total), unless the ground is wet or the water table is high. A very rough estimate of heat loss per 30 meters is 0.6 kW-hour, (2000 BTU) for every 5 °C difference in temperature between the pool water and the ground surrounding the pipe, which translates to about 3% to 5% increase in run time.

3. INSTALLATION AND CONNECTION

3.4 Swimming Pool Heat Pumps Plumbing

The Swimming Pool Heat Pumps exclusive rated flow titanium heat exchanger requires no special plumbing arrangements except bypass (please set the flow rate according to the nameplate). The water pressure drop is less than 10kPa at max. Flow rate. Since there is no residual heat or flame Temperatures, The unit does not need copper heat sink piping. PVC pipe can be run straight into the unit.

Location: Connect the unit in the pool pump discharge (return) line downstream of all filter and pool pumps, and upstream of any chlorinators, ozonators or chemical pumps.

Standard model have slip glue fittings which accept 40mm PVC pipe for connection to the pool or spa filtration piping. By using a 50 NB to 40NB you can plumb 40NB

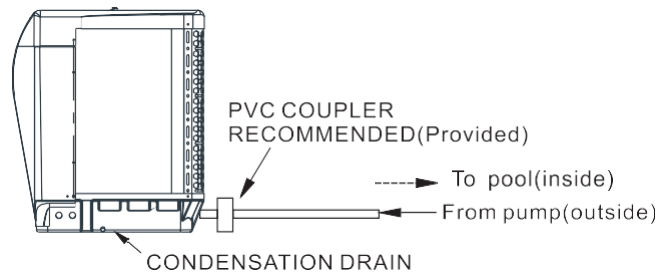

Condensation: Since the Heat pump cools down the air about 4 -5 °C, water may condense on the fins of the horseshoe shaped evaporator. If the relative humidity is very high, this could be as much as several litres an hour. The water will run down the fins into the basepan and drain out through the barbed plastic condensation drain fitting on the side of the basepan. This fitting is designed to accept 20mm clear vinyl tubing which can be pushed on by hand and run to a suitable drain. It is easy to mistake the condensation for a water leak inside the unit.

NB: A quick way to verify that the water is condensation is to shut off the unit and keep the pool pump running. If the water stops running out of the basepan, it is condensation. AN EVEN QUICKER WAY IS to TEST THE DRAIN WATER FOR CHLORINE - if there is no chlorine present, then it's condensation.

3. INSTALLATION AND CONNECTION

3.5 Swimming Pool Heat Pumps Electrical Wiring

NOTE: Although the unit heat exchanger is electrically isolated from the rest of the unit, it simply prevents the flow of electricity to or from the pool water. Grounding the unit is still required to protect you against short circuits inside the unit. Bonding is also required.

The unit has a separate molded-in junction box with a standard electrical conduit nipple already in place. Just remove the screws and the front panel, feed your supply lines in through the conduit nipple and wire-nut the electric supply wires to the three connections already in the junction box (four connections if three phase). To complete electrical hookup, connect Heat Pump by electrical conduit, UF cable or other suitable means as specified (as permitted by local electrical authorities) to a dedicated AC power supply branch circuit equipped with the proper circuit breaker, disconnect or time delay fuse protection.

Disconnect - A disconnect means (circuit breaker, fused or un-fused switch) should be located within sight of and readily accessible from the unit. This is common practice on commercial and residential air conditioners and heat pumps. It prevents remotely-energizing unattended equipment and permits turning off power at the unit while the unit is being serviced.

3.6 Initial startup of the Unit

NOTE- In order for the unit to heat the pool or spa, the filter pump must be running to circulate water through the heat exchanger.

Start up Procedure - After installation is completed, you should follow these steps:

1. Turn on your filter pump. Check for water leaks and verify flow to and from the pool.
2. Turn on the electrical power supply to the unit, then press the key ON/OFF of wire controller. It should start in several seconds.
3. After running a few minutes make sure the air leaving the top(side) of the unit is cooler (Between 5-10 °C)
4. With the unit operating turn the filter pump off. The unit should also turn off automatically,
5. Allow the unit and pool pump to run 24 hours per day until desired pool water temperature is reached. When the water-in temperature reach setting, The unit just shuts off. The unit will now automatically restart (as long as your pool pump is running) when the pool temperature drops more than 2°C below set temperature.

Time Delay- The unit is equipped with a 3 minute built-in solid state restart delay included to protect control circuit components and to eliminate restart cycling and contactor chatter.

This time delay will automatically restart the unit approximately 3 minutes after each control circuit interruption. Even a brief power interruption will activate the solid state 3 minute restart delay and prevent the unit from starting until the 5 minute countdown is completed. Power interruptions during the delay period will have no effect on the 3 minute countdown.

4.USAGE AND OPERATION

4.1 Color screen wire controller interface introduction

4.1.1 Main interface

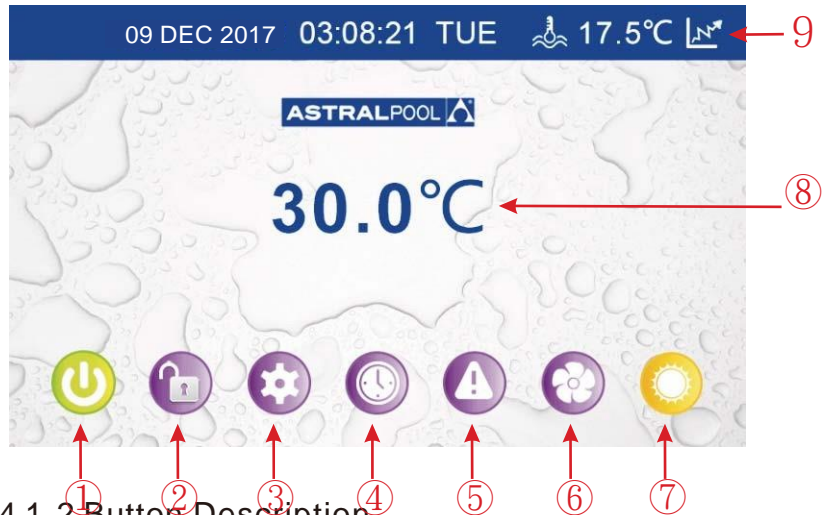

4.1.2 Button Description

NO.	Name	The button function
①	ON/OFF	Press to start /shu t off the unit
②	LOCK	Click to lock the screen , Input "22 " to unlock the screen by press the " lock button"
③	Parameter	Click this button to view the unit state and the parameter
④	CLOCK	Press to set the clock, the timer on or timer off
⑤	Fault display	Click to view fault history
⑥	Silent setting	Click to turn on/off silent function and to set timingLow speed function.
⑦	MODE	Click to enter the mode switch interface
⑧	Water Inlet Temp.	Click to enter mode setting and the target temp. Setting interface
⑨	Temp. curve	Click to view the temp. and power curve

4.USAGE AND OPERATION

4.2 Color screen wire controller function introduction

4.2.1 Booting and shutdown

As shown in figure 1. 1:

In shutdown status, click ① then the unit will be booted

In booting status, click ① then the unit will be shut down.

4.2.2 Mode switch and target temperature Setting

2.2 1 Mode switch

In the main interface, click mode button or inlet water temperature setting button, interface displays as follows:

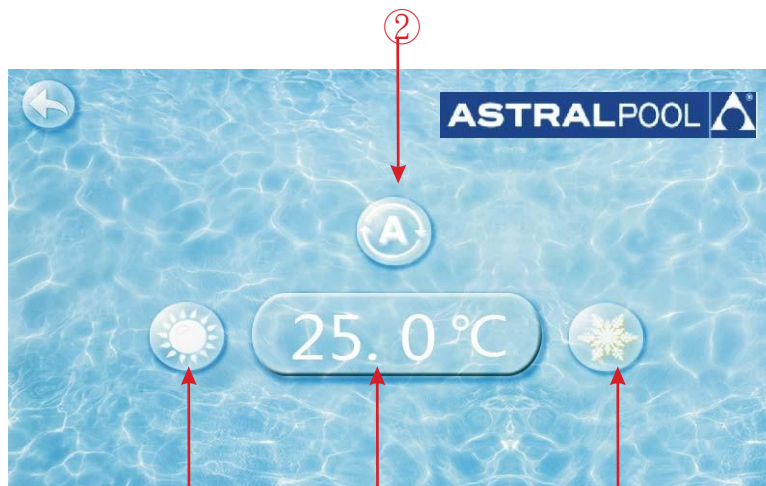

Click the refrigeration mode button ①, automatic mode button ② or heating mode button ③ then you can select the corresponding mode.

Note: when the unit is designed for single automatic mode or single thermal mode, the mode can not be switched.

2.2.2 Target temp. setting

Click the temperature set button ④, you can set the target temperature.

4.USAGE AND OPERATION

4.2.3 Clock setting

In the main interface, click on the clock Settings button, interface displays as follo

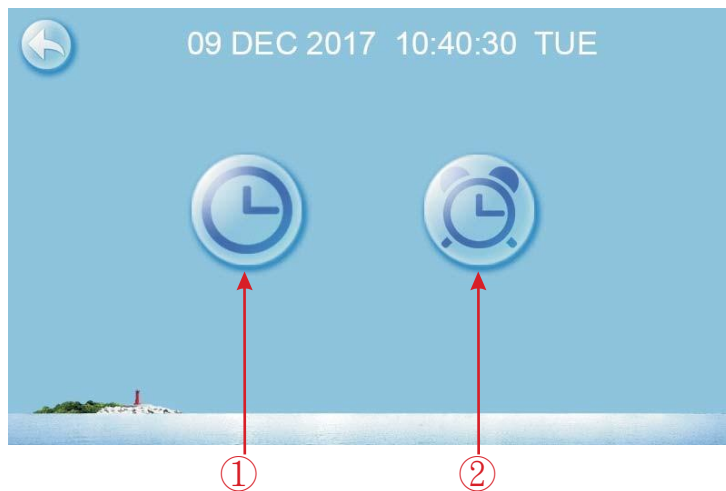

2.3.1 The operation of time setting

Click on the time Settings button ① , interface displays as follows:



Click the value to set time directly, the click confirm button to save the Settings.

For example: setup time: the 30-11-2016 16:00:00, input 30 11 16 16 00 00 , the time change then click confirm button.

Note: if the input format is not correct, the wrong time will be saved by clicking confirm button.

4.USAGE AND OPERATION

2.3.2 The operation of timing setting

Click the timing set button ② to enter timing setinterface.

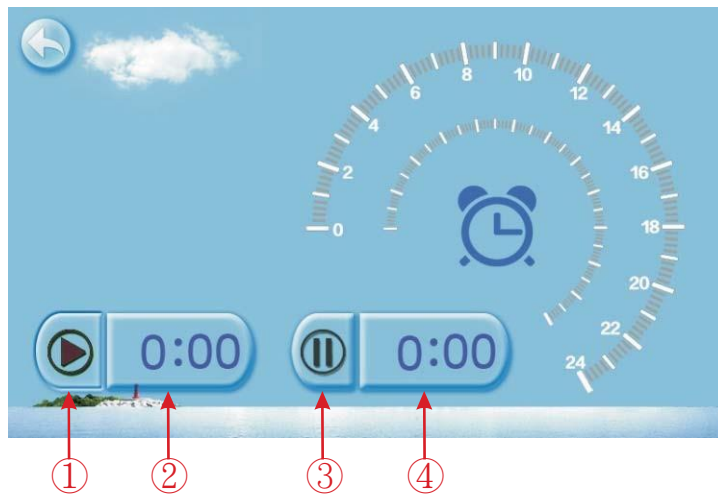

NO.	Name	Button color	Button function
①	Timing start button	Start: green End: gray	Click this button to start or end timing start setting function
②	Timing on setting		Click to set start time of the timing
③	Timing end button	Open: red End: gray	Click this button to start or end timing end setting function
④	Timing off setting		Click to set end time of the timing

For example above: without action, 0 o'clock and 1o'clock will be the on and off time of timing settings.

4.USAGE AND OPERATION

4.2.4 Silent setting and silent timing setting

Click the silent setting button ,and the interface displays as follows:



2.4.1 The silent button

Click the silent button ①, the unit will enter the silent mode, and interface displays as follows:



Click the silent button ① again, to exit the silent mode.

4.USAGE AND OPERATION

2.4.2 Timing silent function setting

Click timing silent button ②, and interface displays as follows:

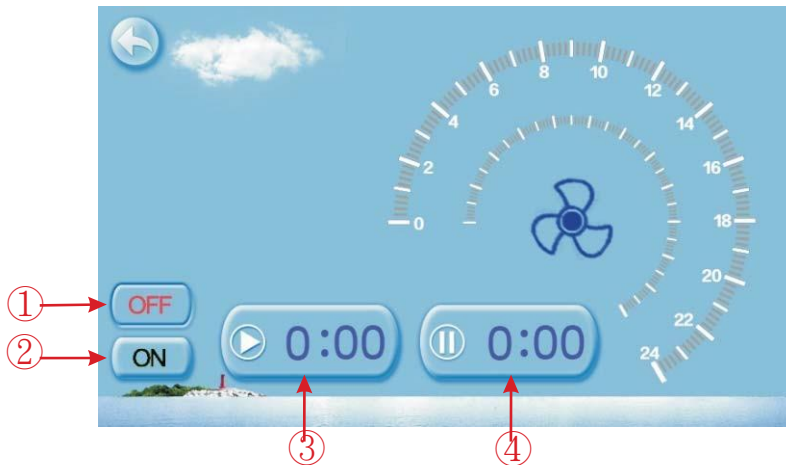

NO.	Name	Color	Function
①	Timing silent off	Used:red Unused:gray	Click to use or unuse timing off function
②	Timing silent on	Use:green Unused:gray	Click to use or unuse timing on function
③	Timing silent start time		Click this button to set the timing silent start time
④	Timing silent end time		Click this button to set the timing silent end time

Start time and end time setting value must be among the range of 0:00-23:00, and setting value can be precise to hour digit.

For example above, click "ON"to use timing silent, the unit will start the silent at 0:00 points and end at 4:00; click "OFF" to unuse the timing silent, but if the unit is in timing silent mode, it will exit silent timing immediately.

4.USAGE AND OPERATION

4.2.5 History of the fault

In the main interface click fault display key, interface displays as follows:



If no failure, main interface displays static "⚠"

When fault occurs, the fault icon will flash between the "⚠" ⚠ ⚠
the failure interface will record time, code, name of the fault.

After troubleshooting, if you do not check the failure record, the main interface will display static "⚠"; if you check the failure record, the main interface will display static "⚠"; Failure record is in reverse order, according to the happening time. Press the "Clean" key, you can delete the fault record.

4.2.6 Color Display Calibration

Keep click quickly at the blank area on any interface till you hear a long beep. Then you will enter the calibration interface. Click "+" to start calibration. When you hear the beep again, you will finish calibration and exit.

Remark: the wire controller can display the temperature unit as "F" or "C" according to the unit model you bought.

4.USAGE AND OPERATION

4.2.7 Temperature curve

In the main interface, click the curve display button,
interface displays as follows:

2.7.1 Temperature recording curve is as follows:

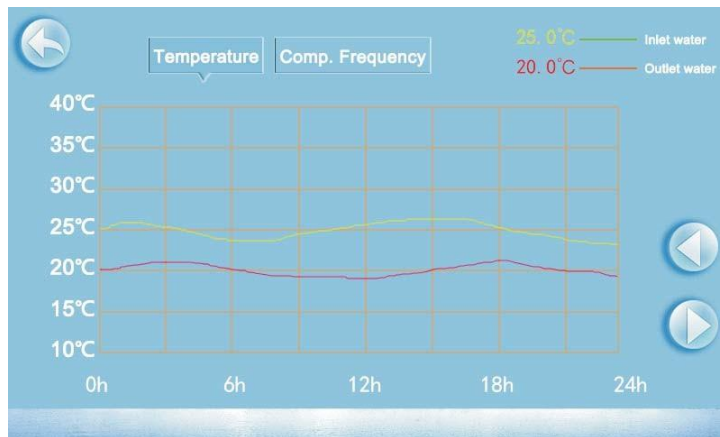

2.7.2 Comp.Frequency curve



Temperature curve automatically updates every one hour, and
the curve record can be stored for 60 days;

Start from the latest curve saved time, if power is off and
curve data collecting time is less than one hour, the data in
this period will not be saved;

4.USAGE AND OPERATION

4.3 Parameter list and breakdown table

(1) Electronic control fault table

Can be judged according to the remote controller failure code and troubleshooting

Protect/fault	Fault display	Reason	Elimination methods
Standby	Non		
Normal boot	Non		
Inlet Temp. Sensor Fault	P01	The temp. Sensor is broken or short circuit	Check or change the temp. Sensor
Outlet Temp. Sensor Fault	P02	The temp. Sensor is broken or short circuit	Check or change the temp. Sensor
Ambient Temp. Sensor Fault	P04	The temp. Sensor is broken or short circuit	Check or change the temp. Sensor
Coil Temp. Sensor Fault	P05	The temp. Sensor is broken or short circuit	Check or change the temp. Sensor
Suction Temp. Sensor Fault	P07	The temp. Sensor is broken or short circuit	Check or change the temp. Sensor
Discharge Temp. Sensor Fault	P081	The temp. Sensor is broken or short circuit	Check or change the temp. Sensor
High Pressure Prot.	E01	The high-pressure switch is broken	Check the pressure switch and cold circuit
Low Pressure Prot.	E02	Low pressure1 protection	Check the pressure switch and cold circuit
Flow Switch Prot.	E03	No water/little water in water system	Check the pipe water flow and water pump
Anti-freezing Prot	E07	Water flow is not enough	Check the pipe water flow and whether water system is jammed or not
Primary Anti-freezing Prot.	E19	The ambient temp. Is low	
Secondary Anti-freezing Prot.	E29	The ambient temp. Is low	
Water-inlet and outlet temp	E06	Water flow is not enough and low differential pressure	Check the pipe water flow and whether water system is jammed or not
Low temperature protection	Non	The environment temp. is low	
Comp. Overcurrent Prot.	E051	The compressor is overload	Check whether the system of the compressor running normally
Exhaust Air over Temp Prot.	P082	The compressor is overload	Check whether the system of the compressor running normally
Communication Fault	E08	Communication failure between wire controller and mainboard	Check the wire connection between remote wire controller and main board
Antifreeze Temp. Sensor Fault	P09	antifreeze temp sensor is broken or short circuited	check and replace this temp sensor
Waterway Anti-freezing Prot.	E05	water temp.or ambient temp. is too low	
EC fan feedback Fault	F051	There is something wrong with fan motor and fan motor stops running	Check whether fan motor is broken or locked or not
Pressure sensor Fault	PP	The pressure Sensor is broken	Check or change the pressure Sensor or pressure

4.USAGE AND OPERATION

Frequency conversion board fault table:

Protection/fault	Fault display	Reason	Elimination methods
Drv1 MOP alarm	F01	MOP drive alarm	Recovery after the 150s
Inverter offline	F02	Frequency conversion board and main board communication failure	Check the communication connection
IPM protection	F03	IPM modular protection	Recovery after the 150s
Comp. Driver Failure	F04	Lack of phase, step or drive hardware damage	Check the measuring voltage check frequency conversion board hardware
DC Fan Fault	F05	Motor current feedback open circuit or short circuit	Check whether current return wires connected motor
IPM Overcurrent	F06	IPM Input current is large	Check and adjust the current measurement
Inv. DC Overvoltage	F07	DC bus voltage>Dc bus over-voltage protection value	Check the input voltage measurement
Inv. DC Lessvoltage	F08	DC bus voltage<Dc bus over-voltage protection value	Check the input voltage measurement
Inv. Input Lessvolt.	F09	The input voltage is low, causing the input current is high	Check the input voltage measurement
Inv. Input Overvolt.	F10	The input voltage is too high, more than outage protection current RMS	Check the input voltage measurement
Inv. Sampling Volt.	F11	The input voltage sampling fault	Check and adjust the current measurement
Comm. Err DSP-PFC	F12	DSP and PFC connect fault	Check the communication connection
Input Over Cur.	F26	The equipment load is too large	
PFC fault	F27	The PFC circuit protection	Check the PFC switch tube short circuit or not
IPM Over heating	F15	The IPM module is overheat	Check and adjust the current measurement
Weak Magnetic Warn	F16	Compressor magnetic force is not enough	
Inv. Input Out Phase	F17	The input voltage lost phase	Check and measure the voltage adjustment
IPM Sampling Cur.	F18	IPM sampling electricity is fault	Check and adjust the current measurement
Inv. Temp. Probe Fail	F19	Sensor is short circuit or open circuit	Inspect and replace the sensor
Inverter Overheating	F20	The transducer is overheat	Check and adjust the current measurement
Inv. Overheating Warn	F22	Transducer temperature is too high	Check and adjust the current measurement
Comp. OverCur. Warn	F23	Compressor electricity is large	The compressor over-current protection
Input Over Cur. Warn	F24	Input current is too large	Check and adjust the current measurement
EEPROM Error Warn	F25	MCU error	Check whether the chip is damaged Replace the chip
V15V over/undervoltage fault	F28	The V15V is overload or undervoltage	Check the V15V input voltage in range 13.5v~16.5v or not

4.USAGE AND OPERATION

(2) Parameter list

Meaning	Default	Remarks
Refrigeration target temperature set point	27°C	Adjustable
Heating the target temperature set point	27°C	Adjustable
Automatic target temperature set point	27°C	Adjustable

4.4 Interface drawin

(1) Wire control interface diagram and definition

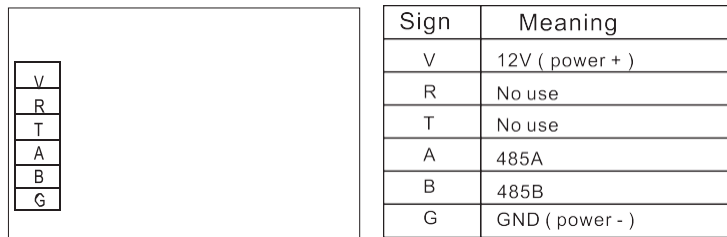

(2) Controller interface diagram and definition

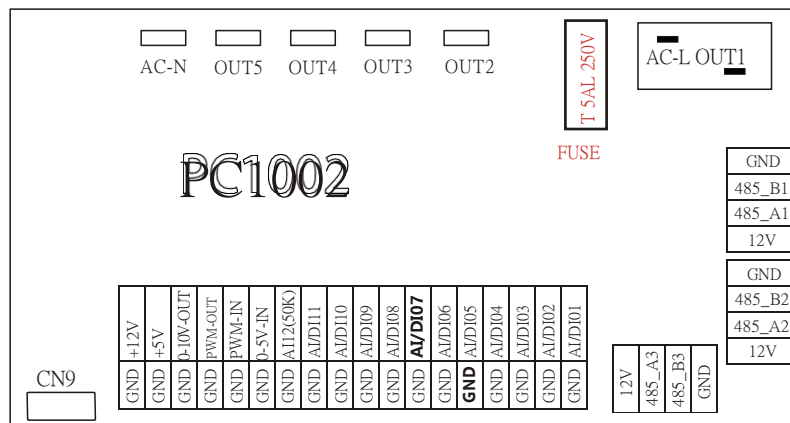

4.USAGE AND OPERATION

Main board of the input and output interface instructions below

Number	Sign	Meaning
01	OUT1	Compressor (output 220-230VAC)
02	OUT2	Water pump (output 220-230VAC)
03	OUT3	4-way valve (output 220-230VAC)
04	OUT4	High speed of fan (output 220-230VAC)
05	OUT5	Low speed of fan (output 220-230VAC)
06	AC-L	Live wire (input 220-230VAC)
07	AC-N	Neutral wire (input 220-230VAC)
08	AI/DI01	Emergency switch (input)
09	AI/DI02	Water flow switch (input)
10	AI/DI03	System low pressure (input)
11	AI/DI04	System high pressure (input)
12	AI/DI05	System suction temperature (input)
13	AI/DI06	Water input temperature (input)
14	AI/DI07	Water output temperature (input)
15	AI/DI08	System fan coil temperature (input)
16	AI/DI09	Ambient temperature (input)
17	AI/DI10	Mode switch (input)
18	AI/DI11	Master-slave machine switch / Antifreeze temperature (input)
19	AI12(50K)	System Exhaust temperature (input)
20	0_5V_IN	Compressor current detection/Pressure sensor(input)
21	PWM_IN	Master-slave machine switch / Feedback signal of EC fan (input)
22	PWM_OUT	AC fan control (output)
23	0_10V_OUT	EC fan control (output)
24	+5V	+5V (output)
25	+12V	+12V (output)
26	GND	Frequency conversion board communications
27	485_B1	
28	485_A1	
29	12V	
30	GND	Color line controller communication
31	485_B2	
32	485_A2	
33	12V	
34	CN9	Electronic expansion valve
35	GND	The port for centralized control I
36	485_B3	
37	485_A3	
38	12V	

5. MAINTENANCE AND INSPECTION

- Check the water supply device and the release often. You should avoid the condition of no water or air entering into system, as this will influence unit's performance and reliability.
You should clear the pool/spa filter regularly to avoid damage to the unit as a result of the dirty of clogged filter.
- The area around the unit should be dry, clean and well ventilated. Clean the side heating exchanger regularly to maintain good heat exchange as conserve energy .
- The operation pressure of the refrigerant system should only be serviced by a certified technician .
- Check the power supply and cable connection often,.Should the unit begin to operate abnormally, switch it off and contact the qualified technician.
- Discharge all water in the water pump and water system ,so that freezing of the water in the pump or water system does not occur. You should discharge the water at the bottom of water pump if the unit will not be used for an extended period of time. You should check the unit thoroughly and fill the system with water fully before using it for the first time after a prolonged period of no usage.

6.APPENDIX

6.1 Caution & Warning

1. The unit can only be repaired by qualified installer centre personnel or an authorised dealer(for Europe market).
2. This appliance can be used by children aged from 8 years and above and persons with reduced physical, sensory or mental capabilities or lack of experience and knowledge if they have been given supervision or instruction concerning use of the appliance in a safe way and understand the hazards involved(for Europe market).
Children shall not play with the appliance .Cleaning and user maintenance shall not be made by children without supervision.
3. Please make sure that the unit and power connection have good earthing, otherwise may cause electrical shock.
4. If the supply cord is damaged, it must be replaced by the manufacturer or our service agent or similarly qualified person in order to avoid a hazard.
5. Directive 2002/96/EC (WEEE):
The symbol depicting a crossed-out waste bin that is underneath the appliance indicates that this product, at the end of its useful life, must be handled separately from domestic waste, must be taken to a recycling centre for electric and electronic devices or handed back to the dealer when purchasing an equivalent appliance.
6. Directive 2002/95/EC (RoHs): This product is compliant with directive 2002/95/EC (RoHs) concerning restrictions for the use of harmful substances in electric and electronic devices.
7. The unit CANNOT be installed near the flammable gas. Once there is any leakage of the gas , fire can be occur.
8. Make sure that there is circuit breaker for the unit, lack of circuit breaker can lead to electrical shock or fire.
9. The heat pump located inside the unit is equipped with an over-load protection system. It does not allow for the unit to start for at least 3 minutes from a previous stoppage.
10. The unit can only be repaired by the qualified personnel of an installer center or an authorized dealer(for North America market).
11. Installation must be performed in accordance with the NEC/CEC by authorized person only (for North America market).
12. Use supply wires suitable for 75°C.
13. Caution: Single wall heat exchanger is not suitable for potable water connection.
14. The appliance shall be installed in accordance with national wiring regulations.
15. The appliance must be fitted with means for disconnection from the supply mains having a contact separation in all poles that provide full disconnection under overvoltage category III conditions, and these means must be incorporated in the fixed wiring in accordance with the wiring rules.
16. An all-pole disconnection switch having a contact separation of at least 3mm in all poles should be connected in fixed wiring.

6.APPENDIX

6.2 Cable specification

(1) Single phase unit

Nameplate maximum current	Phase line	Earth line	MCB	Creepage protector	Signal line
No more than 10A	2×1.5mm ²	1.5mm ²	20A	30mA less than 0.1 sec	n×0.5mm ²
10~16A	2×2.5mm ²	2.5mm ²	32A	30mA less than 0.1 sec	
16~25A	2×4mm ²	4mm ²	40A	30mA less than 0.1 sec	
25~32A	2×6mm ²	6mm ²	40A	30mA less than 0.1 sec	
32~40A	2×10mm ²	10mm ²	63A	30mA less than 0.1 sec	
40 ~63A	2×16mm ²	16mm ²	80A	30mA less than 0.1 sec	
63~75A	2×25mm ²	25mm ²	100A	30mA less than 0.1 sec	
75~101A	2×25mm ²	25mm ²	125A	30mA less than 0.1 sec	
101~123A	2×35mm ²	35mm ²	160A	30mA less than 0.1 sec	
123~148A	2×50mm ²	50mm ²	225A	30mA less than 0.1 sec	
148~186A	2×70mm ²	70mm ²	250A	30mA less than 0.1 sec	
186~224A	2×95mm ²	95mm ²	280A	30mA less than 0.1 sec	

(2) Three phase unit

Nameplate maximum current	Phase line	Earth line	MCB	Creepage protector	Signal line
No more than 10A	3×1.5mm ²	1.5mm ²	20A	30mA less than 0.1 sec	n×0.5mm ²
10~16A	3×2.5mm ²	2.5mm ²	32A	30mA less than 0.1 sec	
16~25A	3×4mm ²	4mm ²	40A	30mA less than 0.1 sec	
25~32A	3×6mm ²	6mm ²	40A	30mA less than 0.1 sec	
32~40A	3×10mm ²	10mm ²	63A	30mA less than 0.1 sec	
40 ~63A	3×16mm ²	16mm ²	80A	30mA less than 0.1 sec	
63~75A	3×25mm ²	25mm ²	100A	30mA less than 0.1 sec	
75~101A	3×25mm ²	25mm ²	125A	30mA less than 0.1 sec	
101~123A	3×35mm ²	35mm ²	160A	30mA less than 0.1 sec	
123~148A	3×50mm ²	50mm ²	225A	30mA less than 0.1 sec	
148~186A	3×70mm ²	70mm ²	250A	30mA less than 0.1 sec	
186~224A	3×95mm ²	95mm ²	280A	30mA less than 0.1 sec	

When the unit will be installed at outdoor, please use the cable which can against UV.

Note: _____

	<p>Correct Disposal of this product</p> <p>This marking indicates that this product should not be disposed with other household wastes throughout the EU. To prevent possible harm to the environment or human health from uncontrolled waste disposal, recycle it responsibly to promote the sustainable reuse of material resources. To return your used device, please use the return and collection systems or contact the retailer where the product was purchased. They can take this product for environmental safe recycling.</p>
---	---

Code: 20000-231607



sales@fluidra.com
www.astralpool.com.au

Fluidra Group Australia Pty Ltd
219 Woodpark Road
Smithfield. N.S.W. 2164
ABN 87 002 641 965