



**ES Series**  
**INVERTER POOL & SPA HEAT PUMP**



**USER MANUAL**



# Table of contents

<b>1.Introduction</b>	<b>1</b>
<b>2.Safety precautions</b>	<b>2</b>
2.1 Warning	2
2.2 Attention	3
2.3 Safety	3
<b>3.About your heat pump</b>	<b>4</b>
3.1 Transportation	4
3.2 Accessories	4
3.3 Features	5
3.4 Operating condition and range	5
3.5 Introduction of different modes	5
3.6 Technical parameter	6
3.7 Dimension	7
<b>4.Installation guidance</b>	<b>8</b>
4.1 Installation reminder	8
4.2 Wiring	10
4.3 Electric wiring diagram	10
4.4 Reference for protecting devices and cable specification.	10
<b>5. Operation guidance</b>	<b>11</b>
5.1 Key function	<b>Error! Bookmark not defined.</b>
5.2 Temperature display	<b>Error! Bookmark not defined.</b>
5.3 Operation instruction	<b>Error! Bookmark not defined.</b>
<b>6.Testing</b>	<b>14</b>
6.1 Inspect heat pump before use.	14
6.2 Refrigerant leakage detection method	14
6.3 Trial	14
<b>7.Maintenance</b>	<b>15</b>
<b>8.Trouble shooting for common faults.</b>	<b>16</b>
<b>9.Water pump connection</b>	<b>18</b>
<b>10.Wi-Fi operation</b>	<b>23</b>
<b>11.Warranty</b>	<b>29</b>

---

# 1.Introduction

Congratulations on the purchase of your new ES Series Heat Pump.

The ES Series Heat Pump has been specifically designed for Pool & Spa applications ensuring optimum performance and many years of trouble-free operation.

Please read and understand this complete user manual before attempting to install your ES Series Heat Pump,

Thank you!



Model Number _____
Serial Number _____
Date of Purchase _____
Invoice Number _____
Please record the information above during installation, as this will be required for any service/warranty work that may be required.

The Sensa-Heat range of products are proudly designed and distributed by:  
Spa-Craft Pty Ltd  
1300 498 819  
20 Curtis Rd Mulgrave  
NSW 2756 Australia

## 2.Safety precautions

We have provided important safety messages in this manual for the installation and upkeep of your heat pump.

**Please thoroughly read and obey all safety messages in this manual.**

**Environment friendly R32 Refrigerant is used for this heat pump.**

### 2.1 Warning



This WARNING sign notes a hazard. It calls attention to a procedure, practice, or the like, which, if not correctly performed or adhered to, could result in personal injury or injury to a third party. These signs are rare but are extremely important.

	a. Keep the heat pump away from fire source.
	b. The Heat Pump must be placed in a well-ventilated area, indoor or enclosed areas are not allowed.
	c. Repair and disposal must be carried out by trained service personnel.
	d. Vacuum the system before welding. Welding can only be carried out by a qualified service technician.

## 2.2 Attention

- a. Please read the following instructions before installation, use and maintenance.
- b. Installation must be carried out by a competent person in accordance with this manual.
- c. Check all plumbing before operating the heat pump, insure there are no water leaks.
- d. Do not obstruct or block air flow near inlet or outlet areas of the heat pump, obstruction to the air flow will greatly affect the efficiency or damage your heat pump.
- e. Carefully set the water temperature on your heat pump to your preference to avoid overheating or overcooling of your Pool/Spa water
- f. To optimize the heating effect, please install heat preservation insulation on pipes between pool/spa and the heat pump, and please use a recommended cover on your pool or spa.
- g. Connecting pipes of the pool/spa and the heat pump should be less than 10m.
- h. Except for the methods recommended by the manufacturer, do not use any methods to accelerate the defrosting process or clean the frosted parts.
- i. If a repair is required, please contact the nearest after-sales service center. The repair process must be strictly carried out in accordance with this manual by an authorized repairer. Unauthorized repairs will void your warranty.
- j. Do not use or stock combustible gas or liquid such as thinners, paint, and fuel near your heat pump as to avoid a fire risk.

## 2.3 Safety

- a. Please keep the main power supply out of reach from children.
- b. When a power cut happens during operating, take caution as the heat pump will automatically restart once power is reestablished.
- c. Please switch off the main power supply in stormy weather to prevent damage that may be caused by lightning strike.
- d. Safety inspection must be carried before the maintenance or repair for heat pumps with R32 gas to minimize the risk.
- e. Any repairs should be conducted in a well-ventilated area. Any ignition source is prohibited during the inspection.
- f. If R32 gas leaks during the installation process, all operations must be stopped immediately and call an authorized service center.

### 3.About your heat pump

#### 3.1 Transportation

a. Always keep upright.

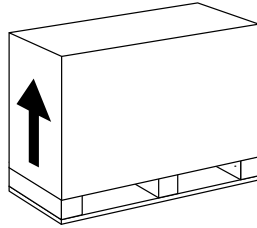

b. Do not lift the heat pump by the water unions as this may cause internal damage to the titanium heat exchanger inside the heat pumps.

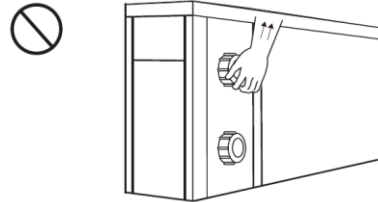

#### 3.2 Accessories

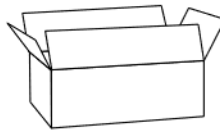
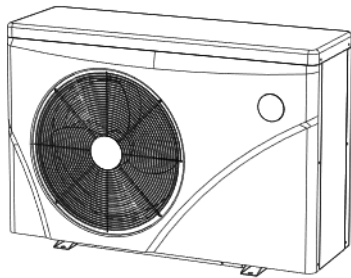

Water Union

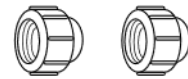

Drainage kit

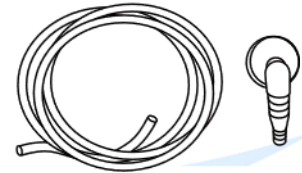

#### Connection of the condensate drainage kit:

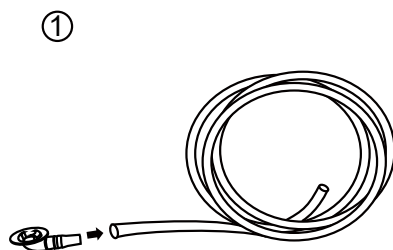

①

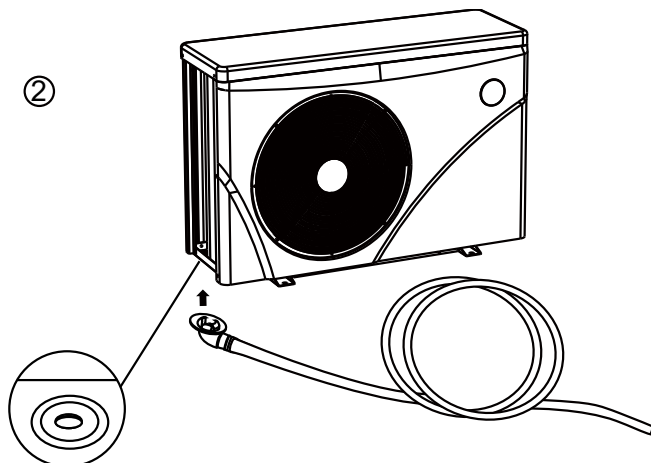

②

### 3.3 Features



- a. Stable DC inverter compressor.
- b. EEV Technology.
- c. Quick reverse cycle defrosting with 4-way valve.
- d. High efficiency twisted titanium heat exchanger.
- e. High pressure and low-pressure protection.
- f. Soft start & wide voltage application.
- g. Stable inverter control system.

### 3.4 Operating condition and range

- a. Air temperature operating range 0°C~43°C
- b. Heating temperatures setting range 18°C~40°C.
- c. Cooling temperature setting range 12°C~30°C
- d. The ideal ambient air temperature for best performance is between air 15°C ~ 25°C.

### 3.5 Introduction of different modes

- a. The heat pump has two modes: Boost and Silence.
- b. They have different strengths under different conditions.

Mode	Modes	Strength
	Boost mode	Heating capacity: 20% to 100% capacity Intelligent optimization Fast heating
	Silence mode	Heating capacity: 20% to 80% capacity Sound level: 3dB(A) lower than Boost mode

### 3.6 Technical parameter

Model	HPES07	HPES09	HPES13	HPES16	HPES20	HPES24
<b>PERFORMANCE CONDITION: Air 27°C/ Water 27°C/ Humid. 80%</b>						
Heating capacity (kW)	7.0	9.0	13.0	16.0	20.2	24.2
COP Range	6~10.1	6.2~10.5	6.3~10.8	6.2~10.7	6.2~10.8	6.3~10.8
<b>PERFORMANCE CONDITION: Air 15°C/ Water 26°C/ Humid. 70%</b>						
Heating capacity (kW)	5.0	6.5	9.0	11.0	14.0	16.0
COP Range	4.3~6.3	4.2~6.5	4.5~6.2	4.3~6.6	4.2~6.5	4.5~6.6
<b>TECHNICAL SPECIFICATIONS</b>						
Advised pool volume(m <sup>3</sup> ) *	15~30	20~45	35~65	40~75	50~90	60~110
Operating air temperature (°C)	0°C~43°C					
Power supply	230V 1Ph					
Rated input current(A)	1.00~5.06	1.21~6.7 3	1.76~8.70	2.17~11.12	2.61~14.16	3.13~16.56
Sound level at 10m dB(A)	19.8~31.2	21.6~33. 5	23.9~34	26.2~37.3	26.3~38.1	26.9~38.7
Advised water flux(m <sup>3</sup> /h)	2~4	3~5	4~6	6~8	7~10	10~12
Water connection (mm)	40					

#### Remarks:

This heat pump can perform normally within an air temperature of 0°C~+43°C, efficiency will not be guaranteed out of this range. Please take into consideration that the pool heat pump performance and parameters are different under various conditions.

Related parameters are subject to adjustment periodically for technical improvement without further notice. Please refer to the ID plate on your heat pump for up-to-date details.



### 3.7 Dimension

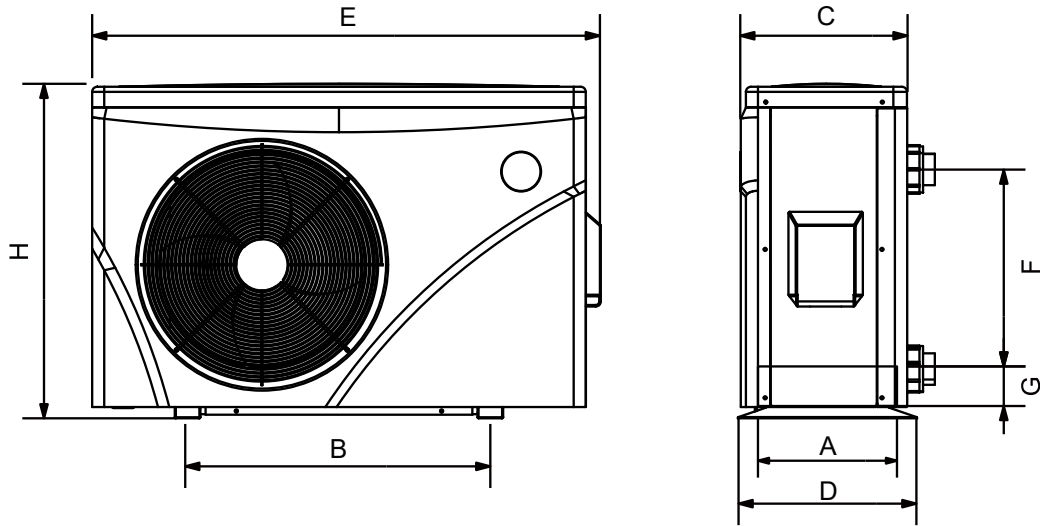

Size (mm) / Name / Model	A	B	C	D	E	F	G	H
<b>HPES07</b>	334	490	341	359	744	310	74	648
<b>HPES09</b>	324	560	347	349	903	250	74	654
<b>HPES13</b>	324	560	347	349	903	320	74	654
<b>HPES16</b>	324	590	347	349	991	350	74	654
<b>HPES20</b>	324	590	347	349	991	350	74	754
<b>HPES24</b>	395	590	415	420	990	460	74	757

※ Above data is subject to modification without notice.

Note: The picture above is the specification diagram of the pool & spa heat pump, for technician's installation and layout reference only. The product is subject to adjustment periodically for improvement without further notice.

## 4. Installation guidance

### 4.1 Installation reminder

Only competent persons are authorized to install the heat pump and should be educated with the relevant building codes and standards of their state or local governing body. All electrical connections must be performed by a licensed electrician.

- a. Location and clearances – see appendix for further ventilation scenarios.
- b. The heat pump should be installed in an outdoor location with adequate ventilation. Installing a heat pump without adequate ventilation will result in poor performance or damage to your heat pump.
- c. The heat pump must be installed in an easily accessible position to ensure easy access when maintenance and service is required.



The inverter heat pump should be installed in an outdoor well ventilation area. The below diagram displays the minimum ventilation area, for optimum performance it is advised to exceed the minimum clearances.

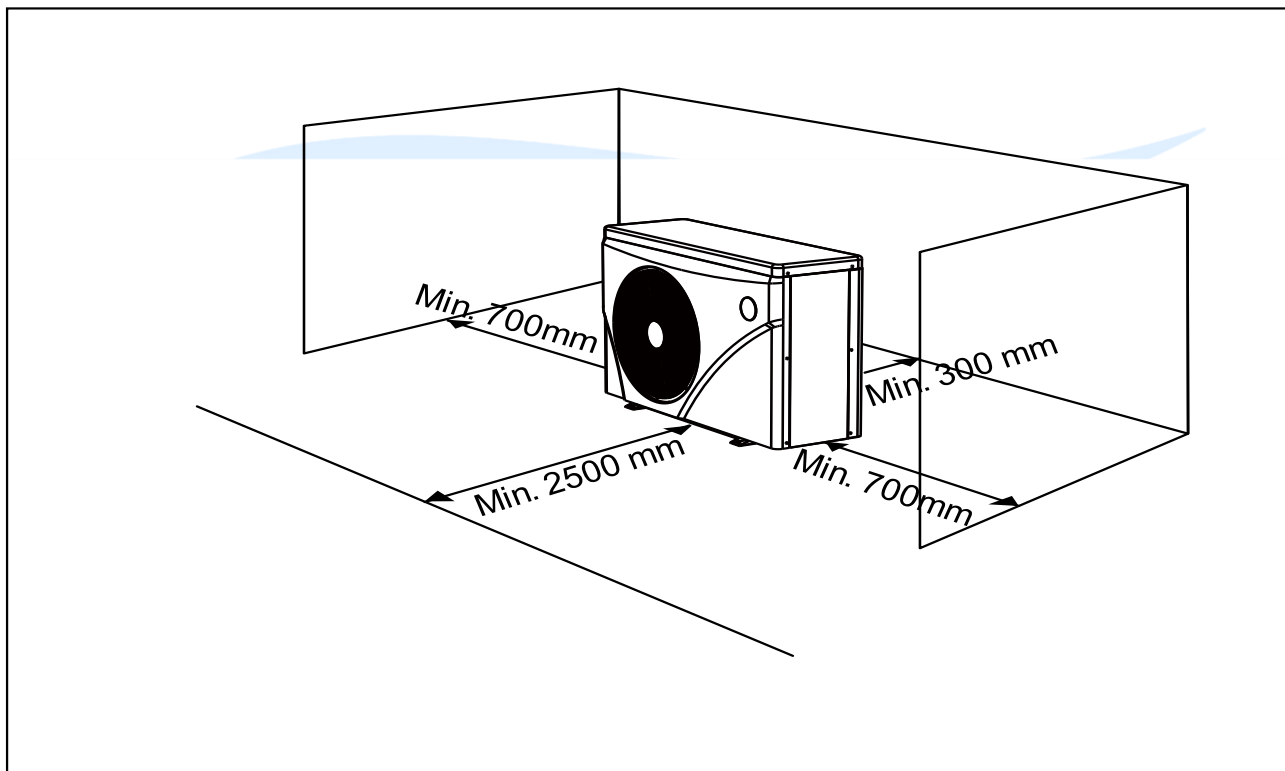

d. Typical plumbing installation diagram,

**NOTE: If installing the heat pump on an existing pump/filtration setup, the heat pump must be installed after the pump/filter and before the chlorinator/sanitizer**

Please note: Water connection locations may differ from the diagram; this diagram is to be used as a guide only!

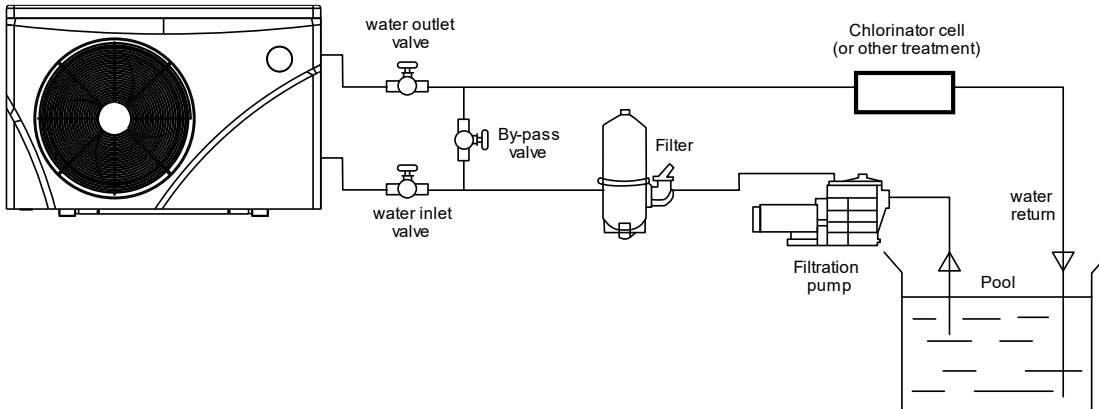

- 1) The frame must be fixed by bolts (M10) to concrete foundation or brackets. The concrete foundation must be solid and fastened; the bracket must be strong enough and antirust treated;
- 2) Do not stack substances that will block air flow near inlet or outlet area, and there is no barrier within 50cm behind the main heat pump, or the efficiency of the heat pump will be reduced or may damage your heat pump
- 3) The heat pump needs an appended water pump (Supplied by the user). The recommended pump must meet required flow rates as per the Technical Parameter, Max. lift  $\geq 10\text{m}$ ;
- 4) When the heat pump is running, there will be condensation water discharged from the bottom of the heat pump. Please insure the drainage nozzle (included with your heat Pump) is inserted into the drainage hole and clip in, connect a pipe to drain the condensation water out.

e. The inlet and outlet water unions cannot stand the weight of flexible pipes. The heat pump must be plumbed with rigid pipes!

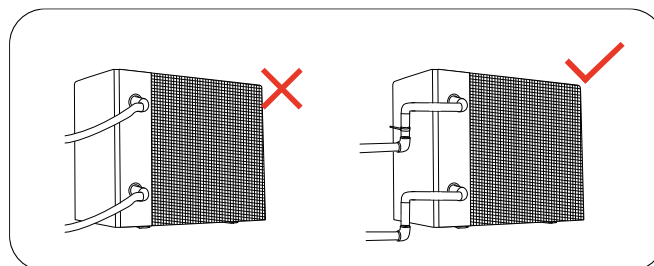

## 4.2 Wiring

- Connect to appropriate power supply, the voltage should comply with the rated voltage of the products.
- Heat pump must be earthed.
- Wiring must be handled by a professional technician according to the circuit diagram.
- Set leakage protector according to the local code for wiring (leakage operating current  $\leq 30\text{mA}$ ).
- The layout of power cable and signal cable should be orderly and not affecting each other.

## 4.3 Electric wiring diagram

For power supply: 230V 50Hz

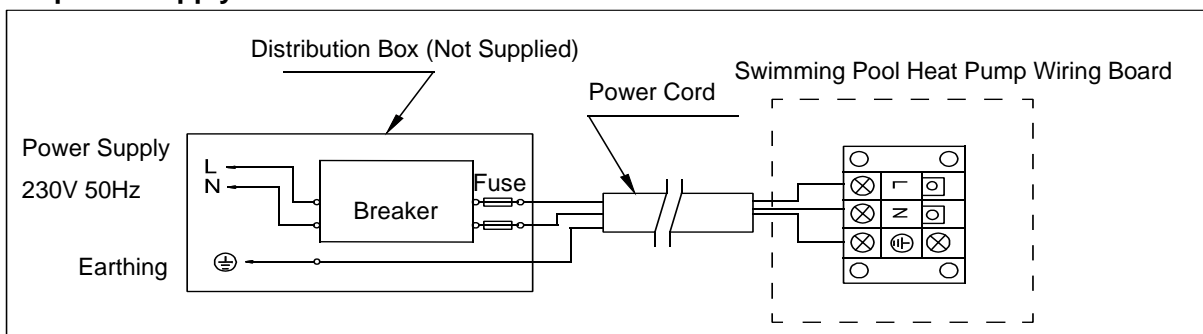

## 4.4 Reference for protecting devices and cable specification.

MODEL		HPES07	HPES09	HPES13	HPES16	HPES20	HPES24
Breaker	Rated Current (A)	8	9.5	15	20.5	23.5	25
	Rated Residual Action Current (mA)	30	30	30	30	30	30

※ Above data is subject to modification without notice.







**Note:** The above data is based on power cables less than 10m long. If the power cable required is more than 10m, wire diameter must be increased in accordance with local power regulations. The signal cable can be extended to 50m maximally.

## 5. Operation guidance

### 1. Key function



---



Symbol	Heating & cooling models
	<ol style="list-style-type: none"><li>1. Power On/Off</li><li>2. Wi-Fi setting</li></ol>
	<ol style="list-style-type: none"><li>1. Lock/Unlock Screen</li><li>2. Heating mode (18-40°C)</li><li>3. Cooling mode (12-30°C)</li><li>4. Auto mode (12-40°C)</li></ol>
	<ol style="list-style-type: none"><li>1. Boost </li><li>2. Silence </li></ol>
	Temperature Setting

### 2. Temperature display

---

Press  and  together for 5 second to switch temperature display.

#### a. Celsius display:

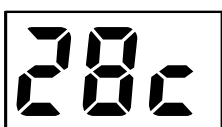

means 28°C

#### b. Fahrenheit display (only the temperature number):



means 104°F

### 3. Operation instruction

#### a. Screen Lock

- 1) Press “” for 3 seconds to lock or unlock the screen
- 2) Automatic Lock Period: 30 seconds if no operation



#### b. Power On

Press “” for 3 seconds to unlock screen. Press “” to power on machine.

#### c. Temperature Setting

When the machine is on, press  and  to set temperature.

#### d. Boost/Silence Mode

Press “” to switch among boost mode , silence mode 

Please choose boost mode  for initial heating

#### e. Heating / Cooling /Auto Mode(heating & cooling models only)

Press “” to switch among heating ” , cooling ”  and auto mode ” .

Heating mode “”: Water temperature setting range(18-40°C)

Cooling mode “”: Water temperature setting range(12~30°C)





Auto mode “”: Water temperature setting range(12~40°C)

\* When water inlet temperature is higher than setting point, automatic cooling mode starts.

\* When water inlet temperature is lower than setting point, automatic heating mode starts.



#### f. Defrosting

- 1) Automatic defrosting: When machine is auto defrosting,  will flash, and return to previous working mode when it finishes.





- 2) Manual Defrosting: To enter forced defrosting mode, the compressor must be working more than 10 minutes. in heating mode, press “” and “” on touch controller simultaneously for 5 seconds to start forced defrosting, ” ” is flashing and defrost starts, “” stop flashing and defrosting stops.

(Remarks: the interval between forced defrosting should be more than 30 minutes.)

### g. Wi-Fi Setting

When the screen is on, press “” for 3 seconds, after “” flashing, enter Wi-Fi connection. Connect Wi-Fi on mobile phone and input password, and then control equipment by Wi-Fi. When APP connects Wi-Fi successfully, “” lights on.

### h. Running Status Checking

- 1) Press “” for 5 seconds, it will enter running status checking.
- 2) During this time, the display will show the status symbol “C0” and its corresponding value.
- 3) Change status through “” and “”, the corresponding value also changes.
- 4) Press “” to quit “Running Status Checking” mode
- 5) Running status checking table:

Symbol	Content	Unit
C0	Inlet water temp	°C
C1	Outlet water temp	°C
C2	Ambient temp	°C
C3	Exhaust gas temp	°C
C4	Evaporator coil pipe temp	°C
C5	Return gas temp	°C
C6	Cooling coil pipe temp	°C
C9	Cooling plate temp	°C
C10	EEV opening angle	P

## 6. Testing

### 6.1 Inspect heat pump before use.

- a. Check the heat pump has adequate ventilation, ensure air inlets and outlets, and are not obstructed.
- b. Ensure heat pump is not installed in a corrosive environment.
- c. Check electric wiring is fasten and wired correctly, ensure unit is fully earthed. (all electrical work must be carried out by a licensed electrician)
- d. Check all plumbing for any water leaks,

### 6.2 Refrigerant leakage detection method



- a. Leakage checking is prohibited in enclosed area.
- b. Any ignition source is prohibited during the leakage inspection. A halide torch (or any other detector using a naked flame) shall not be used.
- c. Leakage detection fluids can be applied with most refrigerants but the use of detergents containing chlorine shall be avoided as the chlorine may react with the refrigerant and corrode the copper pipe.
- d. Vacuumize completely before welding. Welding can only be carried out by professional personnel.
- e. Please stop using while gas leakage occurs and contact professional personnel in service center.

### 6.3 Trial

- a. The water pump must be started before the heat pump and turned off before the heat pump to avoid any damage to the heat pump.
- b. Before starting the heat pump, please check for any water leaks.
- c. To protect the heat pump, the heat pump is equipped with a time lag function, the fan will run for 1 minute before the compressor is turn on and for 1 minute after the compressor has turned off.
- d. After the heat pump starts up, please check for any abnormal noises from the heat pump.

**NOTE: For optimum efficiency, the water inlet to outlet temperature differential should be between 2-3 degrees**

**The running status function on the touch pad will verify inlet and outlet temperatures, adjust water by pass vales to active optimum water flow rates.**



## 7.Maintenance



**“SWITCH OFF” power supply to the heat pump before cleaning, examination and repair**

1. In the winter season when the heat pump is not in operation.
  - a. Cut off power supply to prevent any damage to the heat pump.
  - b. Drain all the water from the heat pump.
  - c. Cover the heat pump when not in use.

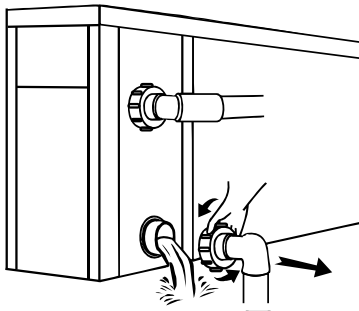

**!!Important:**

Unscrew the water nozzle of inlet pipe to let the water flow out.

*When the water in heat pump freezes in winter season, the titanium heat exchanger may be damaged.*

2. Please clean this heat pump with household detergents or clean water, NEVER use petrol, thinners, or any similar fuel.
3. Check bolts, cables, and connections regularly.
4. If repair or removal is required, please contact authorized service center nearby.
5. Do not attempt to work on the equipment by yourself. Improper operation may cause danger.
6. To reduce risk, safety inspection must be carried out before the maintenance or repair of heat pumps with R32 gas.

## 8. Trouble shooting for common faults.

### 1. Repairing Guidance

---



#### WARNING

- a. If repair or removal is required, please contact an authorized service center.
- b. Requirements for Service Personnel
- c. Any person who is involved with working on or breaking into a refrigerant circuit should hold a current valid certificate from an industry-accredited assessment authority, which authorizes their competence to handle refrigerants safely in accordance with an industry recognized assessment specification.
- d. Do not attempt to work on the equipment by yourself. Improper operation may cause danger.
- e. Strictly comply with the manufacturer's requirements when charging R32 gas and equipment maintenance. This chapter focuses on special maintenance requirements for swimming pool heat pump with R32 gas. Please refer to the technical service manual for detailed maintenance operation.
- f. Vacuumize completely before welding. Welding can only be carried out by professional personnel in service center.

#### Failure solution and code

---

Failure	Reason	Solution
<b>Heat pump does not run</b>	No power	Wait until the power recovers
	Power switch is off	Switch on the power
	Fuse burned	Check and change the fuse
	The breaker is off	Check and turn on the breaker
<b>Fan running but with insufficient heating</b>	Evaporator blocked	Remove the obstacles
	Air outlet blocked	Remove the obstacles
	3 minutes start delay	Wait patiently
<b>Display normal, but no heating</b>	Set temp. too low	Set proper heating temp.
	3 minutes start delay	Wait patiently
If above solutions do not work, please contact your installer with detailed information and your model number. Do not try to repair it yourself.		

**Note:** If the following conditions happen, please stop the heat pump immediately, and cut off the power supply immediately, then contact your dealer:

1. Inaccurate switch action.
2. The fuse is frequently tripping, or leakage circuit breaker tripped.

**Protection & Failure code**

<b>NO.</b>	<b>Display</b>	<b>Protection code description</b>
1	E3	No water protection
2	E5	Power supply exceeds operation range (not failure)
3	E6	Excessive temp difference between inlet and outlet water (Insufficient water flow protection)
4	Eb	Ambient temperature too high or too low protection (not failure)
5	Ed	Anti-freezing reminder (not failure)
<b>NO.</b>	<b>Display</b>	<b>Failure code description</b>
1	E1	High pressure protection
2	E2	Low pressure protection
3	E4	3 phase sequence protection (three phase only)
4	E7	Water outlet temp too high or too low protection
5	E8	High exhaust temp protection
6	EA	Heat exchangers overheat protection/Evaporator overheat protection (only at cooling mode)
7	P0	Controller communication failure
8	P1	Water inlet temp sensor failure
9	P2	Water outlet temp sensor failure
10	P3	Gas exhaust temp sensor failure
11	P4	Evaporator coil pipe temp sensor failure
12	P5	Gas return temp sensor failure
13	P6	Cooling coil pipe temp sensor failure
14	P7	Ambient temp sensor failure
15	P8	Cooling plate temp. sensor failure
16	P9	Current sensor failure
17	PA	Restart memory failure
18	F1	Compressor driver module failure
19	F2	PFC module failure
20	F3	Compressor start failure
21	F4	Compressor running failure
22	F5	Inverter board over current protection
23	F6	Inverter board overheat protection
24	F7	Current protection
25	F8	Cooling plate overheat protection
26	F9	Fan motor failure
27	Fb	Power filter plate No-power protection
28	FA	PFC module over current protection

## 9. Water pump connection

Water pump: 230V voltage,  $\leq 500\text{W}$  capacity

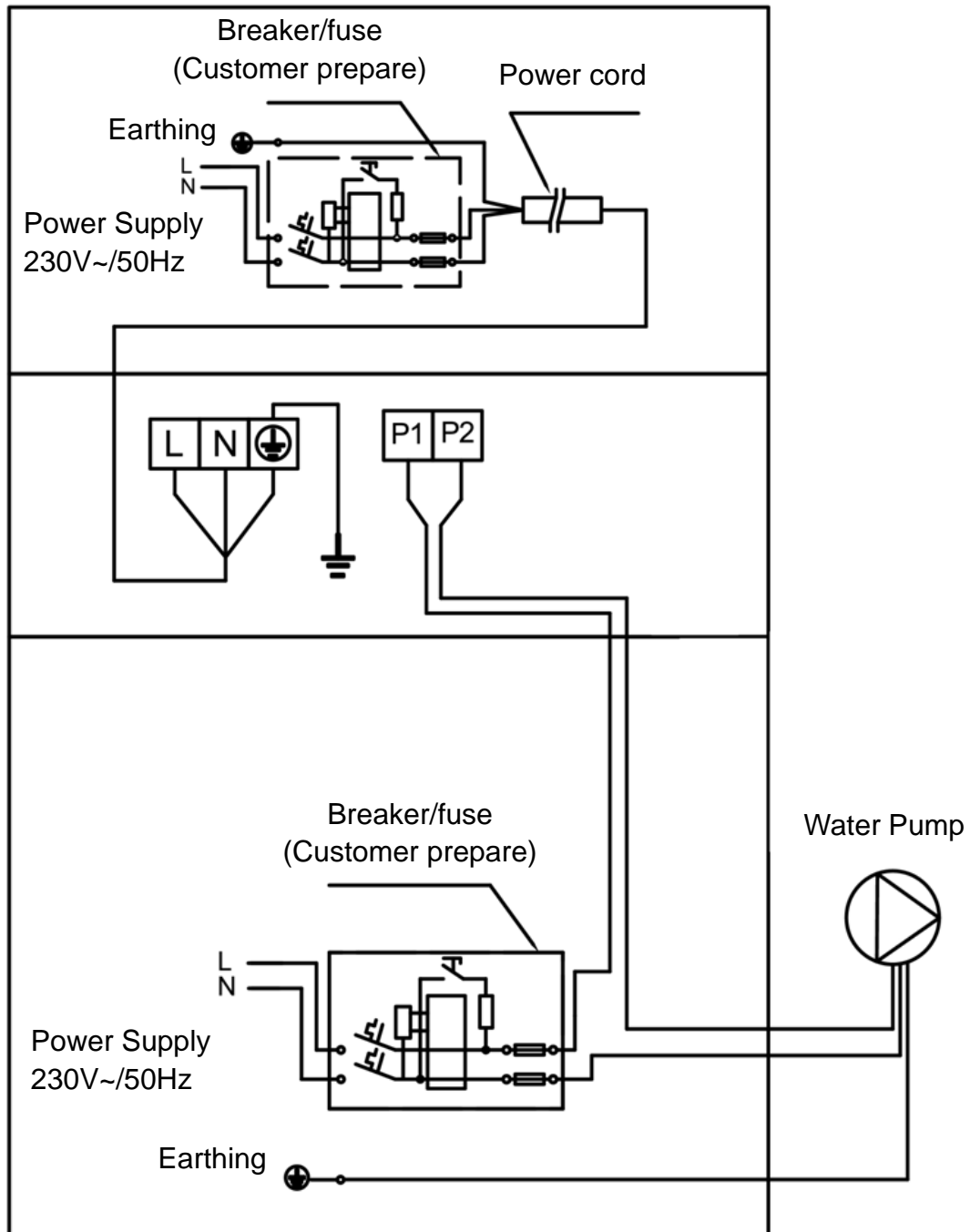

Water pump: 230V voltage,  $\leq 500W$  capacity

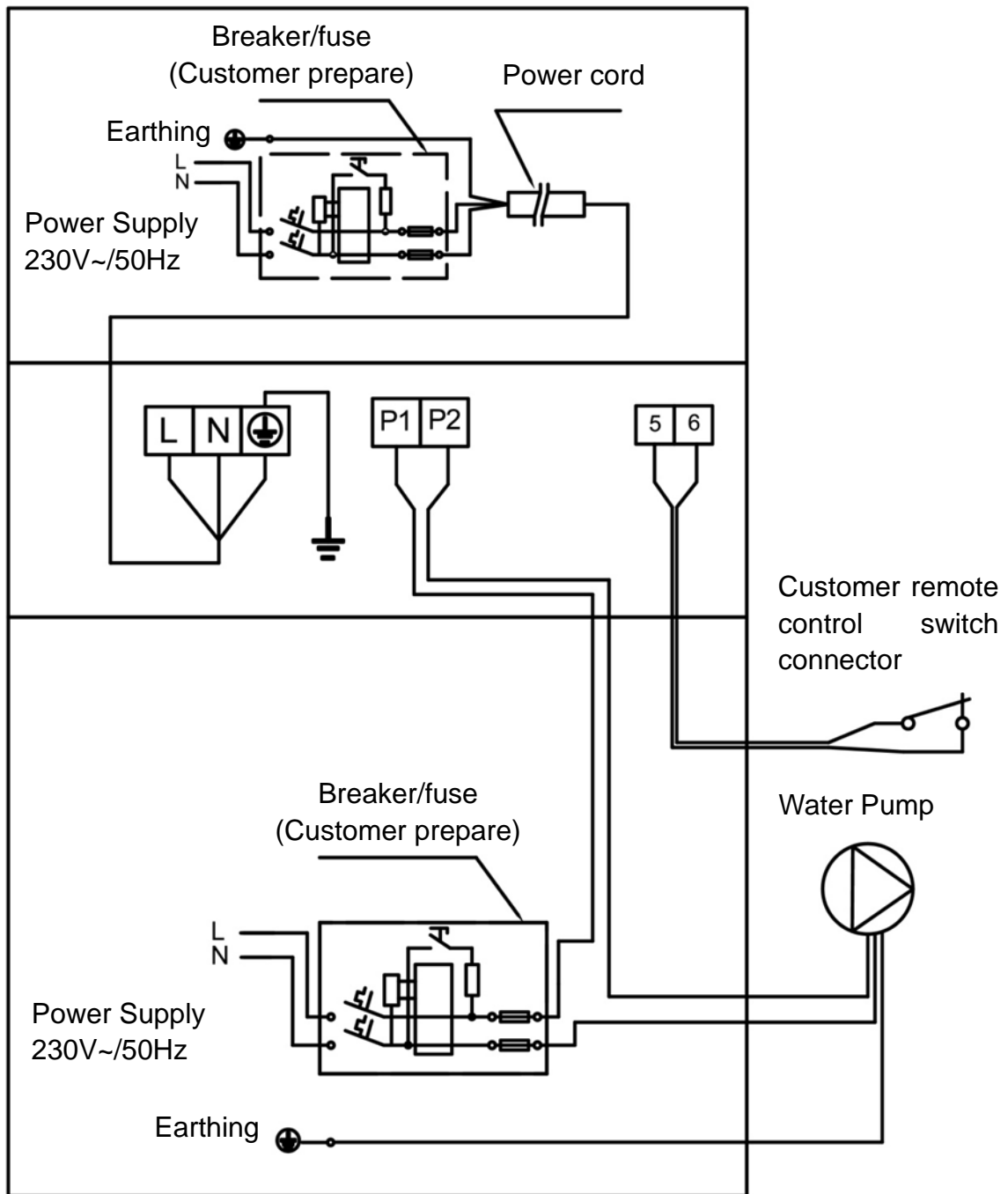

Water pump: 230V voltage, >500W capacity

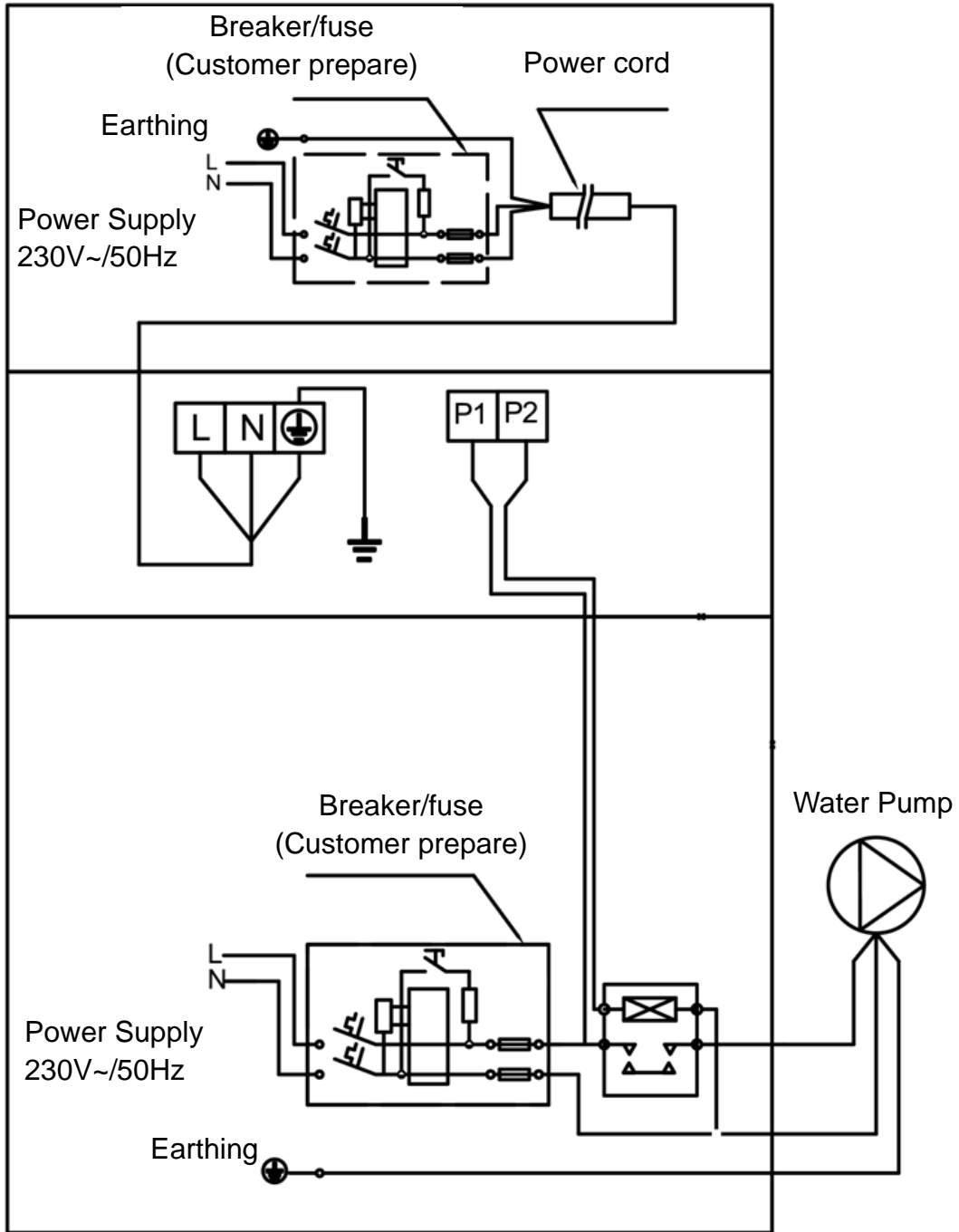

Water pump: 230V voltage, >500W capacity

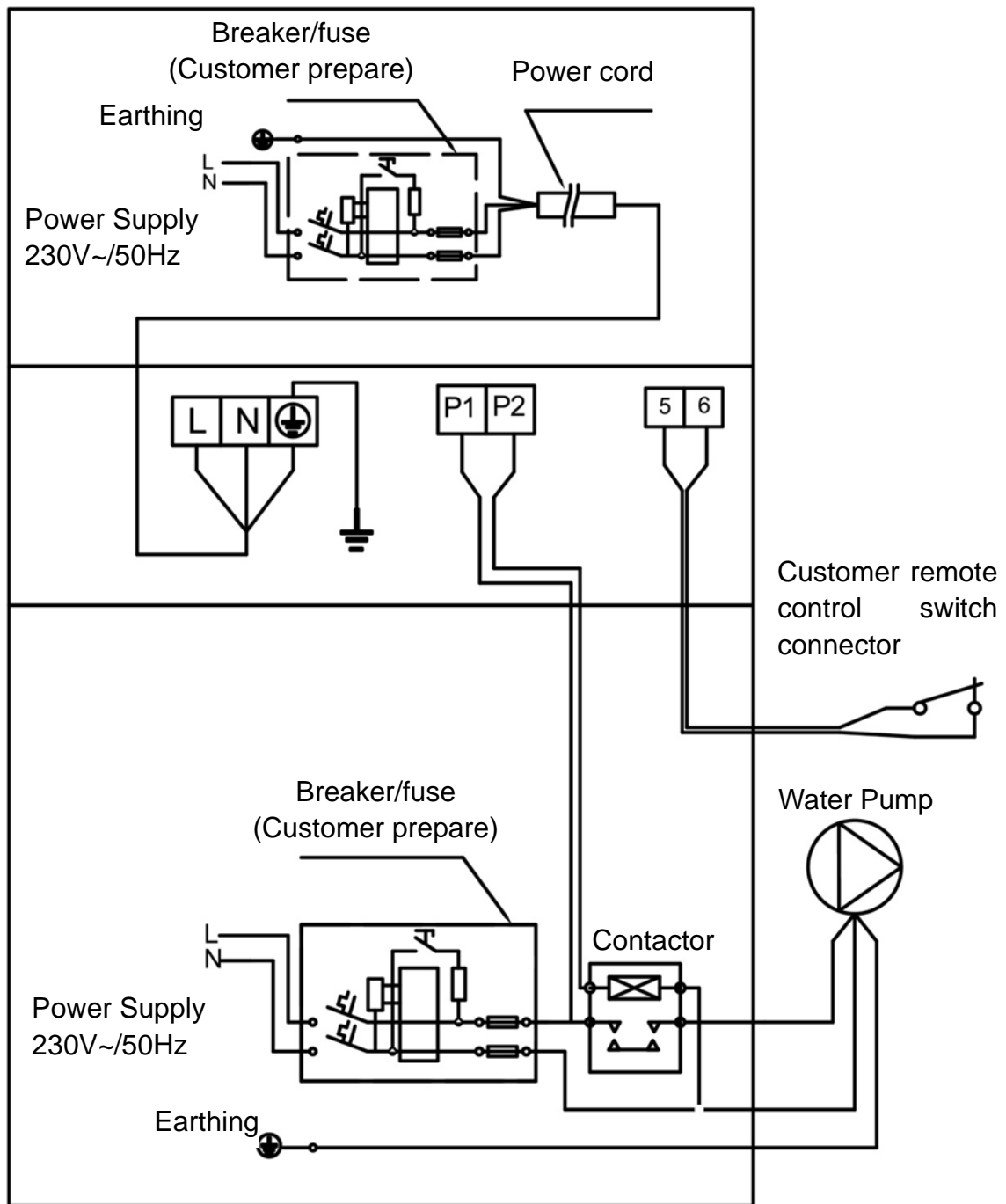

## Water pump control and timer connection

1: Water pump timer

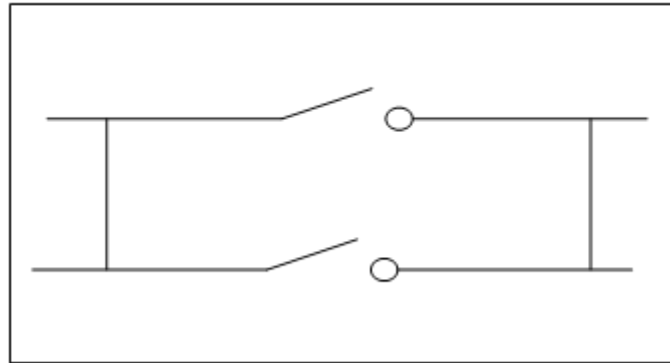

2: Water pump wiring of Heat Pump

Note: The installer should connect 1 parallel with 2 (as above picture). To start the water pump, condition 1 or 2 is connected. To stop the water pump, both 1 and 2 should be disconnected.



## 10. Wi-Fi operation

### 1 InverGo Download



Android



iOS



### 2 Account Registration

Register by e-mail or third-party application.

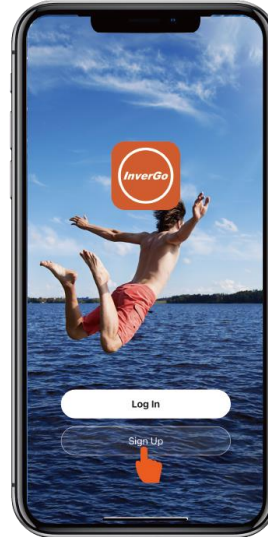

#### a. E-mail registration.

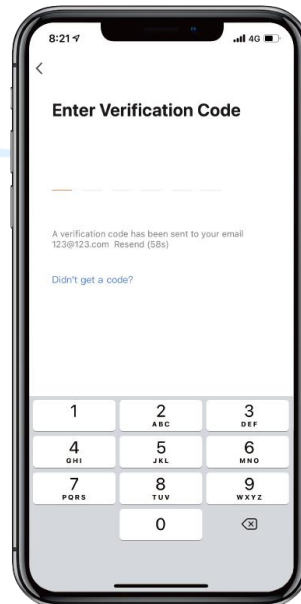
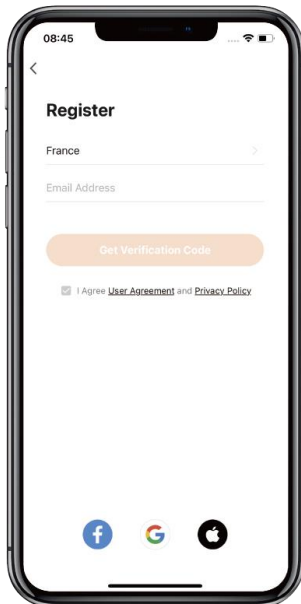

## b. Register through third-party application

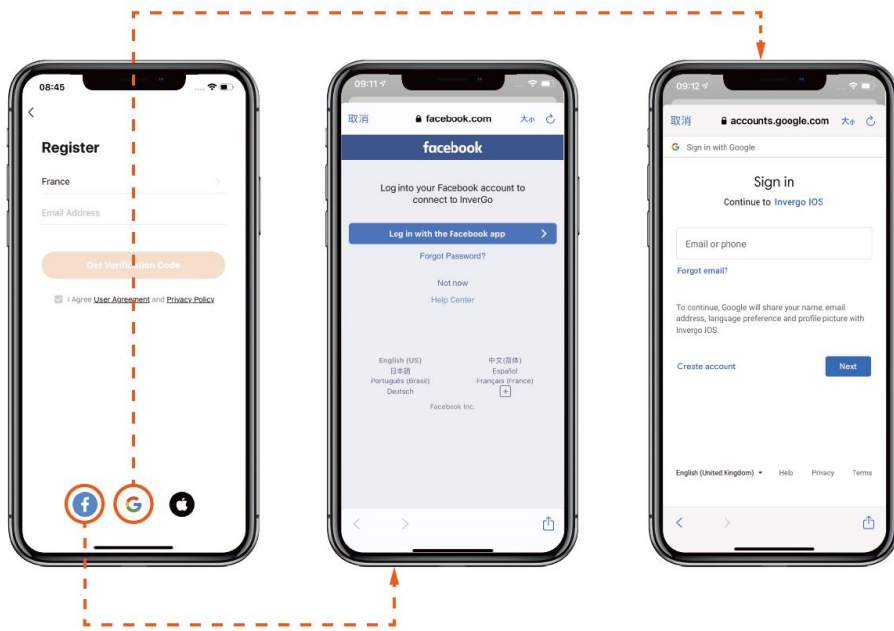

## 3 Create Family

Please set family name and choose location of device.

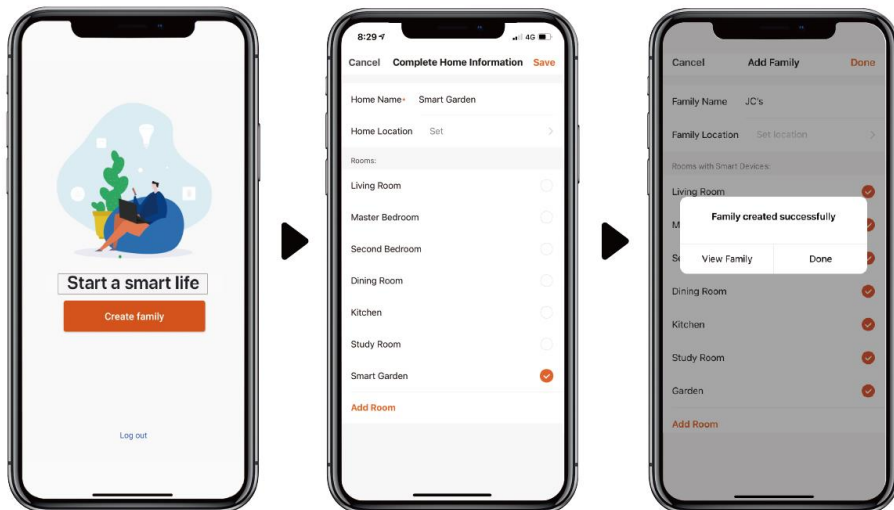

## 4 APP Pairing

### a. With Bluetooth

1. Please confirm that you're connected to Wi-Fi and your Bluetooth is on.
2. Click "Add Device", and then follow the instructions to pair device.

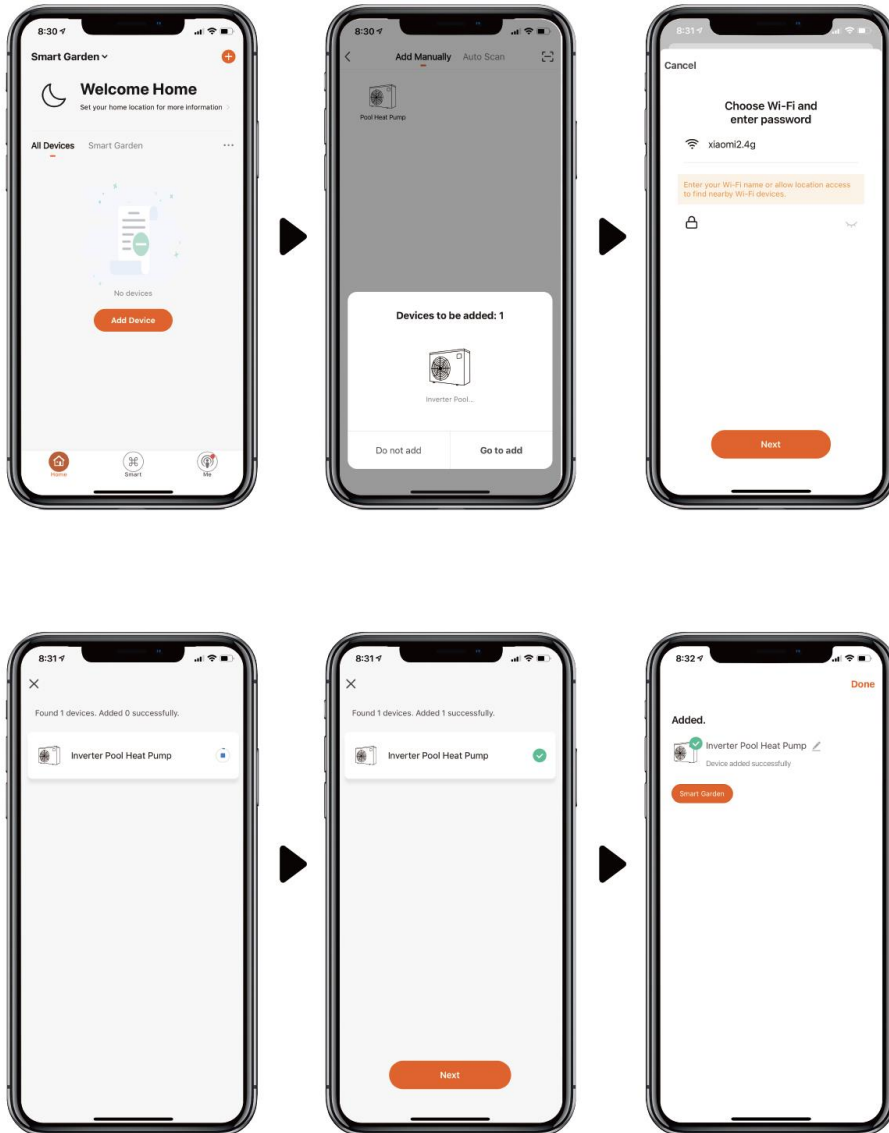

## b. With Wi-Fi

1. Please make sure you are connected to Wi-Fi.

2. Press "**U**" for 3 seconds to unlock the screen. Press "**U**" for 3 seconds and release. After hearing "Beep", enter Wi-Fi password in app. During connection "Wi-Fi" will flash. Once the app connects to Wi-Fi successfully, "Wi-Fi" will display.



3. Click "Add Device", and then follow the instructions to pair

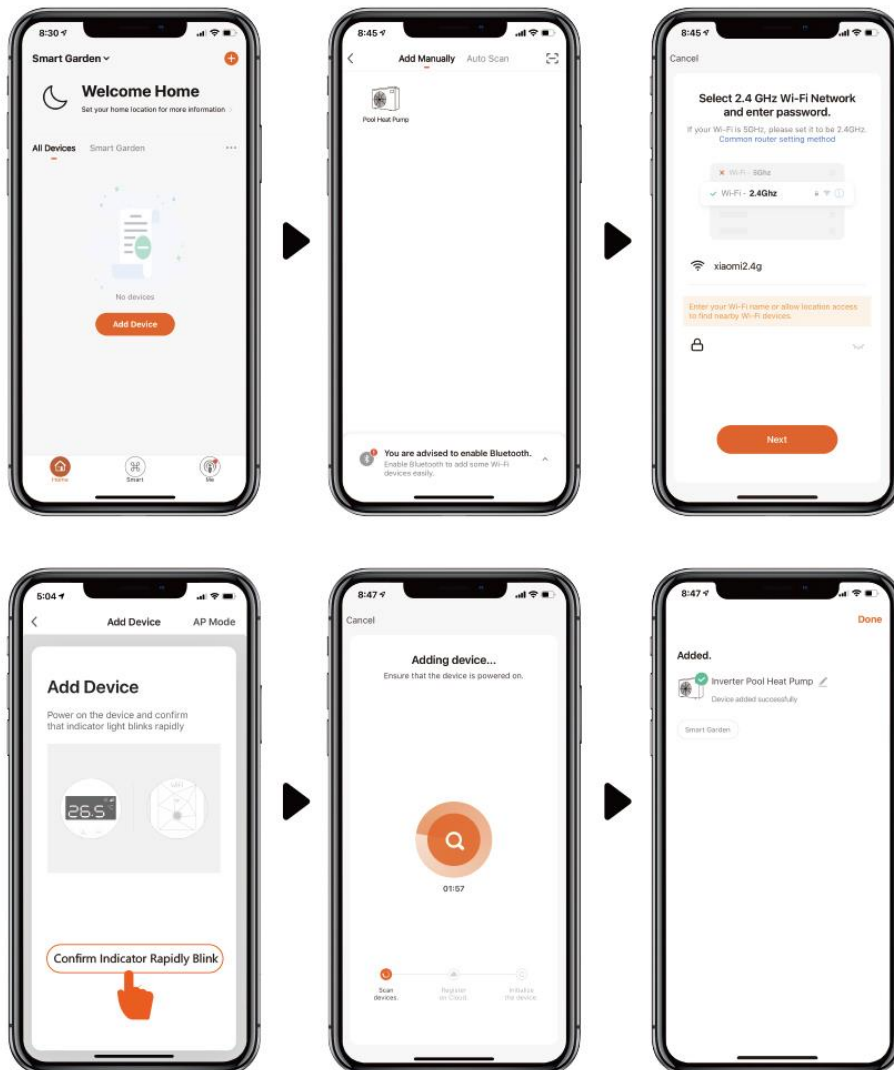

## 5 Operation

1. For heat pump with Heating function only:

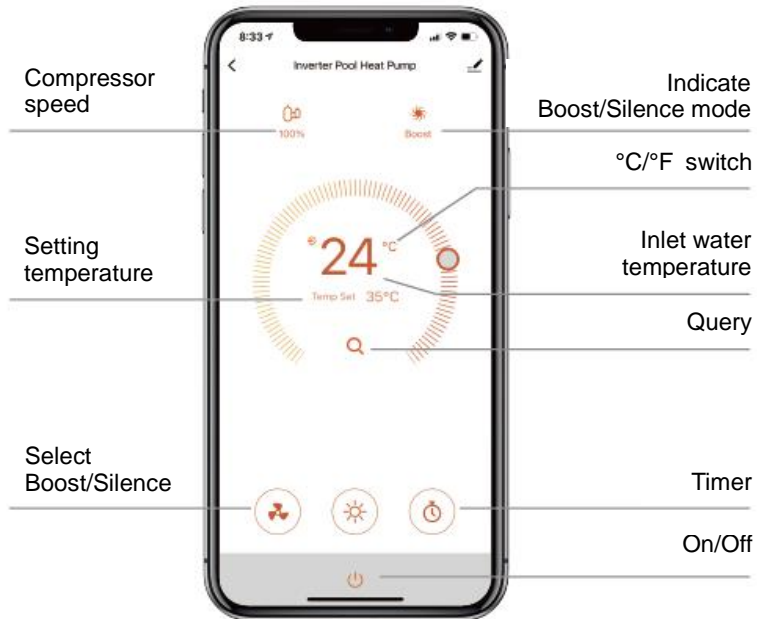

2. For heat pump with Heating&Cooling function:

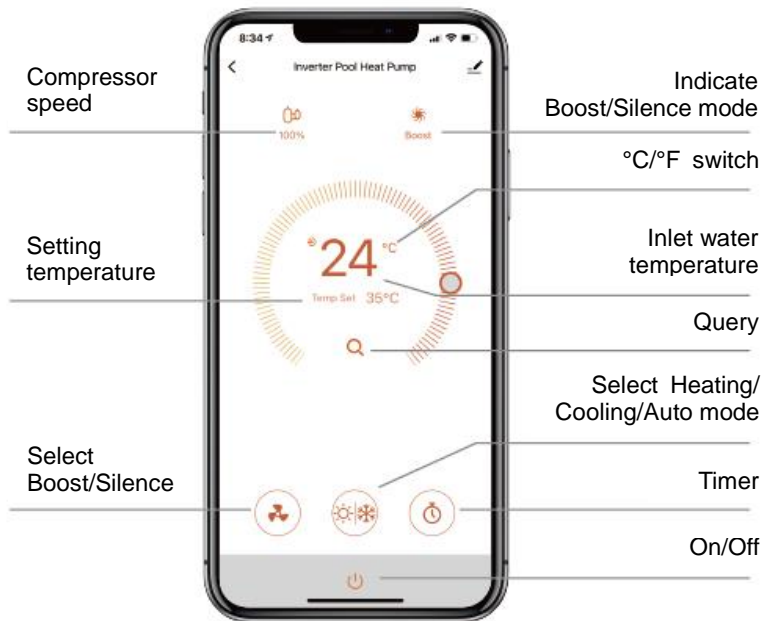

## 6 Share Devices to Your Family Members

After pairing, if your family members also want to control the device, please let your family members register “InverGo” first, and then the administrator can operate as below:

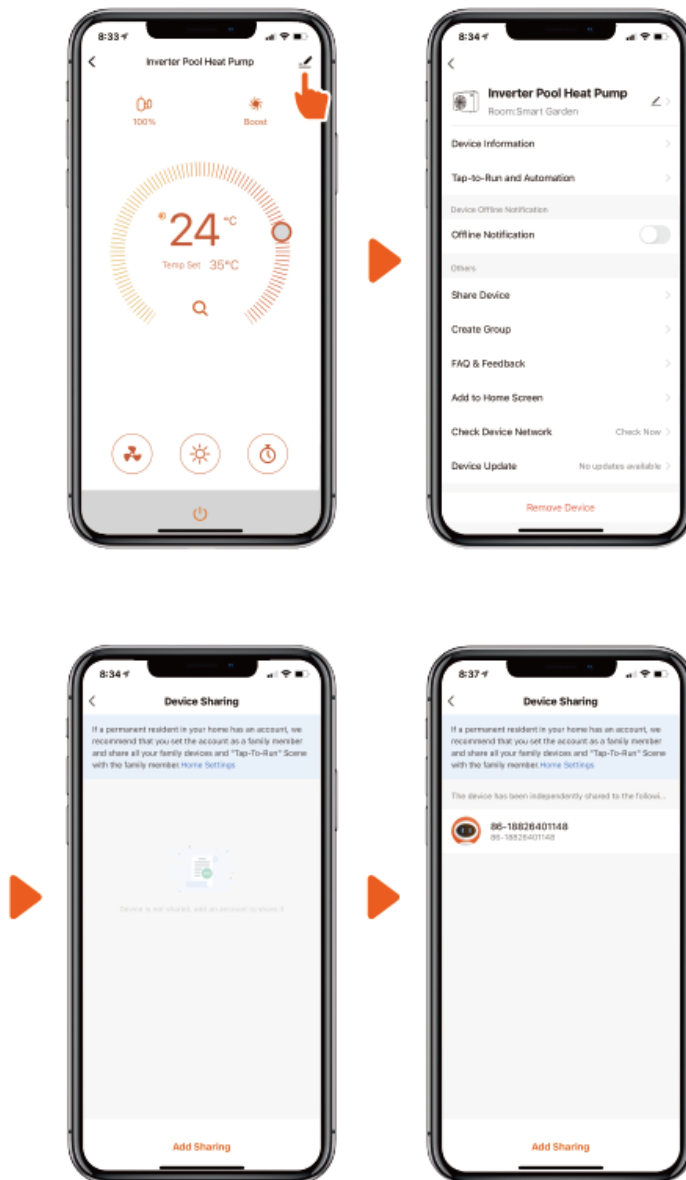

Notice:

1. Weather forecast is just for reference.
2. App is subject to updates without notice.

## 11. Warranty

Spa-Craft Pty Ltd (Spa-Craft) warrants all products sold will be (under normal use and service) free of defects in material and workmanship for a minimum period of one year from the date of original purchase by the customer as marked on the invoice, for specific product warranty periods please refer to below table.

Spa-Craft goods come with guarantees that cannot be excluded under the Australian Consumer Law. You are entitled to a replacement or refund for a major failure and compensation for any other reasonably foreseeable loss or damage. You are entitled to have the goods repaired or replaced if goods fail to be of acceptable quality and the failure does not amount to a major failure. No unauthorized personnel can make any warranty representation on the behalf of Spa-Craft without written permission.

Model	Titanium Heat Exchanger	Compressor	Parts	On-Site Labour
ES Series	25 years	3 years	2 years	1 year
PI Series	25 years	5 years	2 years	1 year

### This warranty does not cover the following:

- normal wear and tear
- been subject to misuse, neglect, negligence, damage, or accident
- been used, operated, or maintained other than in accordance with Spa-Craft instructions
- not been installed in accordance with the Installation Instructions or by suitably qualified personnel
- been modified or altered from original specifications or in any way not approved by Spa-Craft
- had repairs attempted or made by other than Spa-Craft or its authorized dealers
- been subject to abnormal conditions such as incorrect voltage supply, lightning, or high voltage spikes, or damages from electrolytic action, cavitation, sand, corrosive, saline or abrasive liquids, Natural Disasters

### To make a warranty claim:

- If the product is suspected of being defective, stop using it and contact the original place of purchase. Alternatively, phone Spa-Craft Customer Service on 1300 498819 or via email to [info@spa-craft.com.au](mailto:info@spa-craft.com.au)
- Provide evidence or proof of date of original purchase
- Provide model number and serial number.
- If requested, return the product and/or provide further information with respect to the claim. Returning the product to the place of purchase is at your cost and is your responsibility.
- The warranty claim will be assessed by Spa-Craft based on their product knowledge and reasonable judgement and will be accepted if:
  - a relevant defect is found
  - the warranty claim is made during the relevant warranty period; and none of the excluded conditions listed above apply
- The customer will be notified of the warranty decision in writing and if found to be invalid the customer must organise collection of the product at their expense or authorise its disposal.

If the claim is found to be valid Spa-Craft will, at its option, repair or replace the product free of charge.

### On Site Service

Onsite technical service is available within the normal operating area of your Spa-Craft service center, service outside this area will incur a traveling fee.

AQ43CM-R32-V22

